



AXA
KRYPTONITE
TRELOCK

Allegion OEM

Catalogue





The Allegion OEM catalogue

Before you lies the **Allegion OEM catalogue**. Your guide in specifying your bicycles with; lights, locks and guards. This catalogue contains a summary of the best we have to offer from our combined brands and portfolios.

For each product we have stated the most standard available options, of course custom adaptations as different colours, cable lengths, connectors and special brackets are possible. Your Allegion contact person can help you with the details.

Further we would like to draw your attention to the many customised solutions we have offered in the past and can offer you in the future.

Allegion: best solution for every bike and brand

3

3 strong brands that appeal to consumers



Global production and supply chain



The best product portfolio for any brand and model



Increased innovation power



High customer service



Global brands serving global markets

Allegion helps keep people safe where they live, work and visit. As a leading provider of security products and solutions for homes and businesses, Allegion specialises in security around the doorway and beyond: everything from residential and commercial locks, door closers and exit devices, to access control and workforce productivity systems.

Continual product development across the product ranges delivers innovative access and security solutions for the differing requirements within the healthcare, education, hospitality, transport and commercial markets worldwide.

AXA ■  BRICARD ■ Brio ■ Briton ■  CISA ■ FALCON

GLYNN-JOHNSON ■  ITO ■ IVES ■ KRYPTONITE ■ LCN ■ NORMBAU ■  SCHLAGE

Simons  Voss ■ STEELCRAFT ■  TRELOCK ■ VON DUPRIN ■  ZERO INTERNATIONAL

© 2024 Allegion plc. Bricard, Briton, CISA®, Falcon®, Glynn-Johnson®, INSPEC, ITO™, Ives®, LCN®, Normbau®, Schlage®, Steelcraft® and Von Duprin® are the property of Allegion plc. All rights reserved. All other brand names, product names or trademarks are the property of their respective owners.

Our 3 strong bike brands

AXA

AXA Bike Security

More than 120 years of expertise

AXA Bike Security is inextricably linked to cycling culture. For more than 120 years, the company has made every effort to optimally protect the cyclist and the bike. As a real bike fan, AXA Bike Security knows exactly what cyclists need to safely and confidently hit the road. Our developers transform the latest preferences and developments into user friendly, sustainable products. Thanks to our own production facilities in Europe we can always guarantee consistent high quality. This way AXA contributes to the safety and pleasure of the growing worldwide group of people who embrace the bike as a healthy and sustainable means of transportation.

TRELOCK

TRELOCK

Quality, innovation and reliability

TRELOCK is a traditional brand from Münster – the “bicycle capital” of Germany. It is one of the oldest German accessory brands and one of the most well-known in the bicycle sector - in fact it is a brand every fourth cyclist in Germany is aware of. Besides, over the past ten years, TRELOCK has been able to double its brand awareness (GfK survey 2015).

Our customers are at the focus of our actions. At the same time, the TRELOCK team is committed to the tradition of the brand and takes innovation in the field of bicycle locks, lighting and displays very seriously – today and in future for the benefit of cyclists in many countries of the world. With the know-how gathered over more than 160 years, TRELOCK stands for high-quality and reliable products for international markets.

KRYPTONITE

Kryptonite

Protect what you value

Over 40 years ago, Kryptonite began with a mission. While much has changed in bicycling, and bicycle security, our objective remains the same, we are here to empower you to protect what you value.

Through constant innovation, expert guidance, and our never-ending commitment, Kryptonite will continue to pursue our passion and do everything we can to ensure you can go where you want, when you want by offering smart, serious security solutions.

Sales and customer Service in every time zone

Allegion is always around the corner. With many offices all around the globe we are always available to give you full support with specifying your bicycles, handling orders and any other support we can offer.

With own production plants in Poland, France and the Netherlands and dedicated partners in the far east and offices through out Europe, the United States and Asia we can not only guarantee high quality products but also short lead times to European and Asian bicycle factories.



Supply chain

We do not only ensure production and quality-control processes, but also coordinates worldwide logistics, working with qualified forwarding agents to deliver to OEM customers.

Quality

All our employees actively live the high Allegion quality standards thus creating continuous quality processes from the product development phase through production right up to the customer service.

Allegion has invested in new testing laboratories at each individual sites, and applies the latest test procedures. Our dedicate Allegion quality engineers in the Far east ensure that our dedicated partners fulfill the same high standards.

Our products fulfil the quality criteria of the most important testing authorities, and are therefore able to receive the major, internationally-accepted certifications.



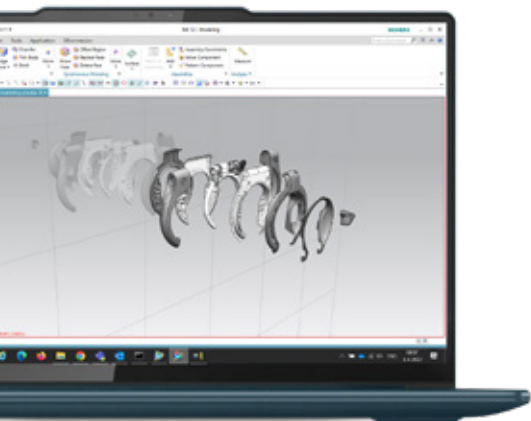

Customised solutions

Endless possibilities

The bicycle industry is a dynamic and constantly evolving field that requires a well-coordinated process from ideation to design to engineering to produce high-quality products. We can help you with a custom made product, from lights to mechanical locks and to electronical safety and security.

Show your brand identity

No bicycle is a like. To empower brands we help producers to create the optimal bicycle for them. Our locks and lights can be tailored to the needs of each individual brand. Sometimes you want a signature component on your bicycle. Something which clearly shows your brand identity.

In cooperation with leading bicycle manufacturers solutions are generated which become an uniform ensemble with the bicycle. Our lock and light systems and the display technique are totally modulated due to the customer wishes.

Technology, shape and colour: with Allegion everything is possible. Our joint development projects lead to solutions that are becoming standard in the industry. Numerous innovations result in solutions that have proven themselves time and again.



From ideation to design and engineering

The strongest innovation platform

We have multiple centers of excellence with dedicated engineers and industry specialists to bicycle locks, lights and IOT. What distinguishes us: an open mind for all ideas, complete answers, fast processes, tailor made and outstanding solutions. We are dedicated, creative and the partner of choice around the world.



The process

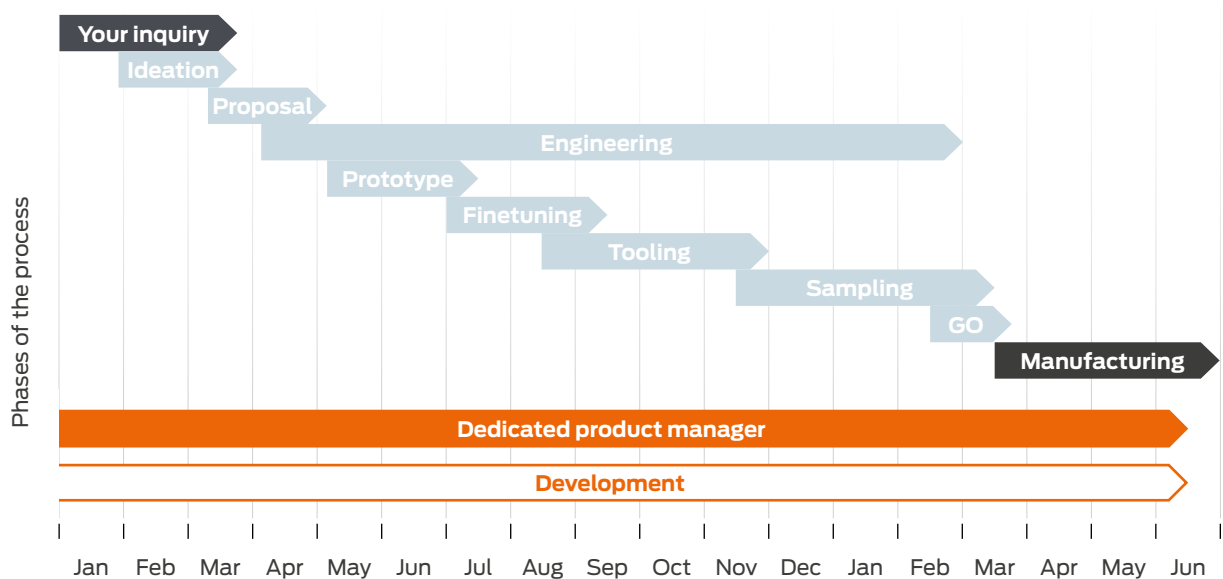

Customized lights

Lights are often an eyecatcher on a bicycle and offer possibilities for your own signature. Custom lights will give your bike that unique personal touch which can be an outstanding design element or nicely integrated into the frame of the bicycle.

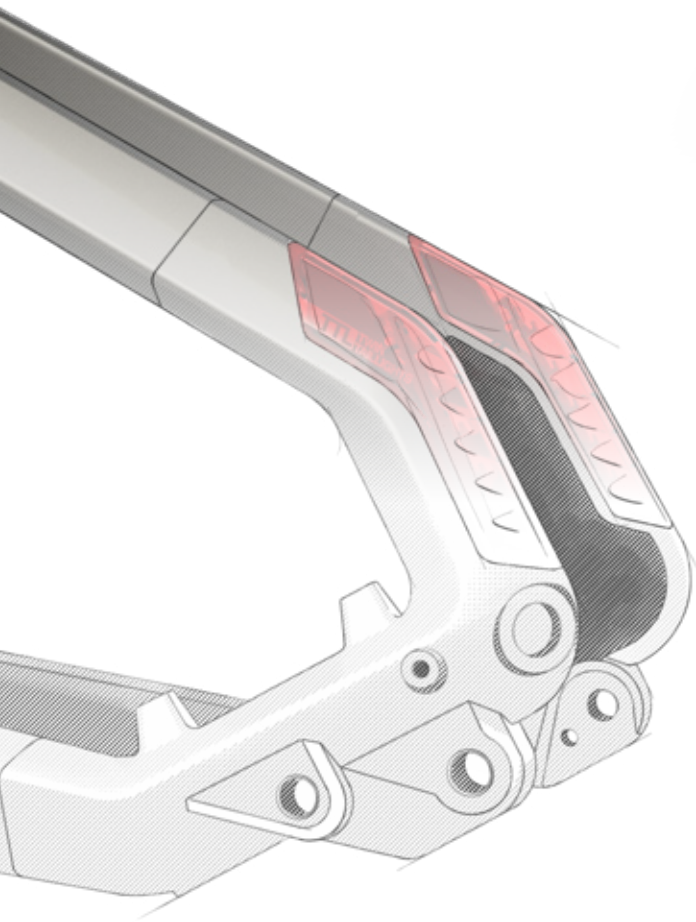

Twin Taillights

Combined with the Skybeamer we created the directly in frame integrated Twin-Tail taillights for Haibike. One bike with this eyecatching design will have 16 LEDs for perfect visibility and safety.

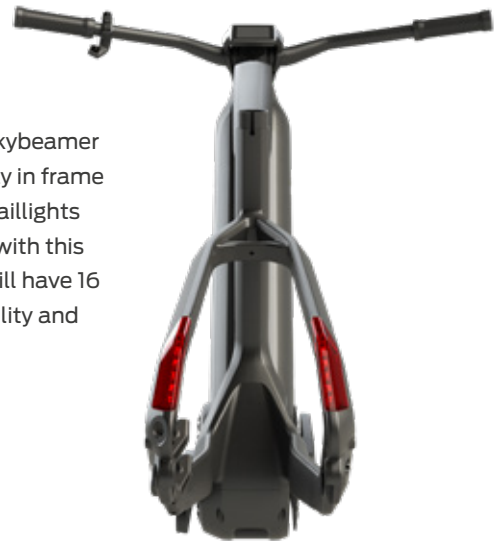

Integrated front light

Displayed is the 5000 lumen E-MTB headlight called Skybeamer. Together with Haibike we also developed the Skybeamer 150 and 300. The Skybeamer is developed in three special solutions for Bosch, Yamaha and TQ.



Centurion Halo

Displayed is the integrated Centurion carrier rear light. The light is customized specifically for the Centurion carrier to be on Centurion's high-end E-MTB's and E-trekking bikes and impresses with a powerful and seamlessly looking light contour to the carrier.



Integrated carrier rear light

This top integrated modern LED lighting technology provides uniform light for maximum safety: durable integration into the rack, brake light function, shock resistant, robust and brightly radiating.



Digital Light Projection (DLP)

DLP Technology allows projection of all kinds of information on the street. For example, instructions or warnings in the form of icons, logos or animations. Adaptations are easily uploaded. The possibilities are endless which make the bike ride more fun, more comfortable and most important safer.



Brand identifier

For Sparta Bikes we created a LED logo integrated in the bicycle frame front fork which is a uniform ensemble with the bicycle and makes the Sparta brand stand out.



Customized locks

integrated frame lock

A very aesthetic and distinctive solution is the integrated frame lock or cable lock, created for the ultimate convenience for your end users. For ease of use there is the possibility to get the lock cylinder keyed alike with the cylinder of the battery case from the E-Bike.

battery lock

This design smartly locks away the e-bike battery behind the rear light. The battery case and the frame lock can be locked with just one key for the highest comfort.



Integrated cable lock

A very aesthetic solution is the possibility for a cable lock fully integrated in the carrier. With this plug-in chain in combination with a frame lock you can to secure your bike to a fixed object.

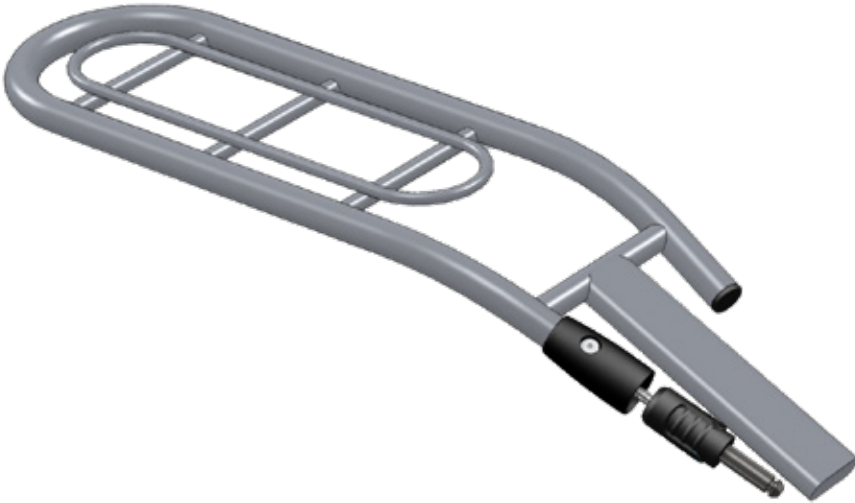

Cortina Basket Lock

Expensive extra's such as dog or grocery baskets, mounted on your (front) carrier are for grabs for quick thieves. With the basket lock integrated in the carrier - custom designed and developed for Cortina - this practice is now a thing of the past.

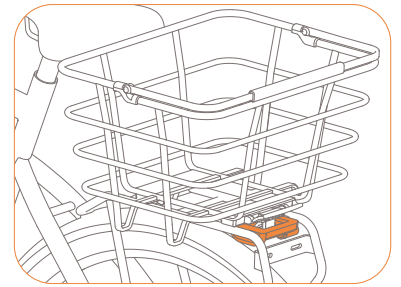

Derby bracket

The custom 'Derby' folding lock bracket for e-bikes has a clever locking mechanism that fixes the lock in the holder, so it doesn't rattle while riding. It is mounted behind the seatpost for perfect integration into the bike's design.

Integrated folding lock

Both our specializations resulted in a contemporary design of a lock & light solution which is high in convenience for the bike manufacturer. The same applies for the battery lock.

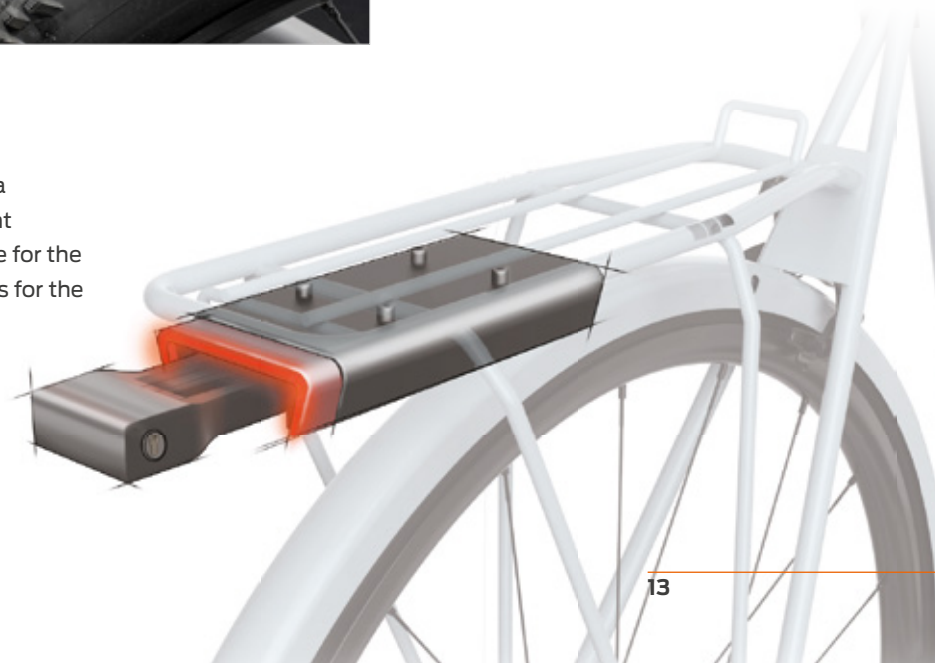

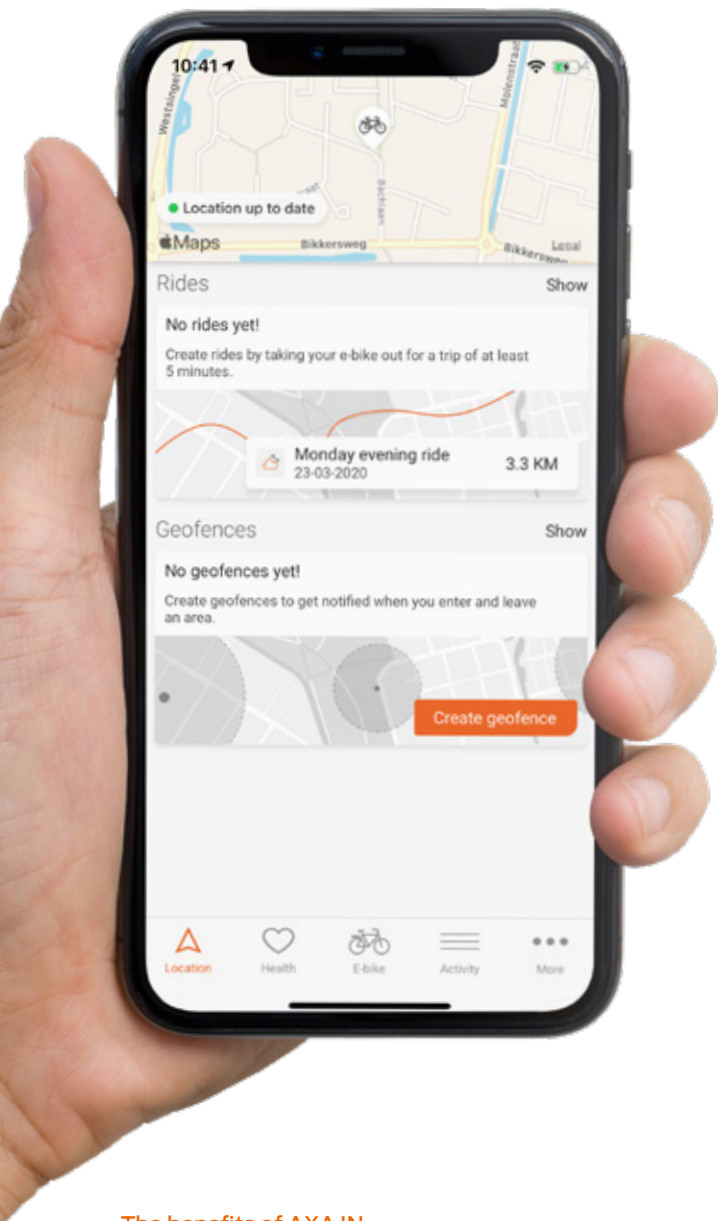

AXA E-rental Bike sharing made easy

For bike rental and sharing companies Allegion has the perfect solution:
The Electronic ring lock.

The Electronic ring lock

We offer a highly secured lock with a user-friendly experience which can easily be integrated into an existing bike sharing platform. The lock can be mounted quickly and easily on a regular frame of a bike. Cyclist can conveniently rent or take a bike and lock it for a stop where ever they prefer. With an additional plug-in chain the bike can be secured to the fixed world and detected for a safer lock up.

The Electronic ring lock is available in two versions. A Bluetooth low energy version, the lock can be opened with an app on your phone. Or a wired version which can be opened with an RFID chip or card.

The benefits of AXA IN

- Maximum security
- No more hassle with keys or codes
- Easy to integrate into existing bike rental or sharing platforms
- For docking and dockless solutions
- Use of standard bikes
- Possibilities for pay per minute
- **NEW** Quick release locking for stop-park-go use
- **NEW** Additional security by plug-in recognition



Plug-in chain with sensor



E-RL Bluetooth®

No keys

By means of Bluetooth® Low Energy the lock **A** is paired to the phone of the consumer **B** and the lock can be opened or closed easily without the hassle of keys.

Authorization

Authorization to open is given via your own reservation system **C** with use of the top of the line secured key-encryption of AXA's key server Key Safe Cloud **D**. To ensure proper and secure locking of the bike, the locking procedure always needs to be done manually. For ease of use during stop-park-go's the AXA E-RL BLE 2 offers a quick release button on the bike which will give you the option to lock down the bike without using the app.



Authorization by Smartphone (Bluetooth®)



E-RL Wired

The AXA IN Electronic ring lock can easily be connected to your existing on bike IOT device.

This is the ideal solution for large bike sharing and rental projects with their platform and communication already in place. Whether you communicate to your customer by smart phone, card or any other type of communication, AXA offers you the opportunity to link the Electronic lock to it.

The E-RL Wired offers you power and communication via wire to the IOT device. Whilst AXA offers you a secure and robust hardware solution, you can link to the platform and app of your choice.

Authorization

The Electronic ring lock **A**, connects to the IOT device **B**, which communicates to your platform **C**.

It is a simple and safe way of sharing bicycles with an app on a smartphone and is ideal for medium and large bike sharing and rental projects.



Authorization by card

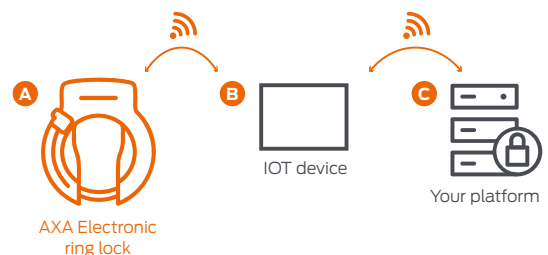

AXA Connect

Making cycling smarter

With the internet of things people are able to connect to devices and control them remotely through an app on a mobile device. Consumers demands are changing due to 24/7 connectivity by using smart devices. They demand customised service and relevance. Due to increasing competition the bike industry faces the challenges to innovate and fulfill these new demands. Consumers expect is; technology is ready for it. And the smart solution, AXA IN, is up for it!

How does it work?



GPS signal

The module in the bike receives the GPS signal via satellite links.



GPRS connection

The module creates an internet connection from the bike via GPRS.



Internet server

The module sends the location to an internet server which stores the data.



AXA IN App

The consumer can see, among other things, the location of his bike in the app.

Connected bike

Know everything about the bike

With this smart solution consumers can stay connected with their bike. This solution has different functions like the Track & Trace function. This provides the exact location of the bike. There is also AXA Alert. This puts a virtual fence around the bike using geofencing technology. As soon as the bike is outside that area, is moved or falls over, the owner receives a notification. Furthermore, you'll get a warning if the

bike is travelling faster than 50 km/h. You can assume in that case that the bike has been taken and is being transported on a trailer or in a van.

Besides the bike security options, there are a number of fun items as well. The number of kilometres ridden, the number of calories burned and the CO² emissions savings. These items can all be shared via social media. With the AXA Family Care you can add bikes from the whole family. The parent will receive a message when the child has arrived safely at school.

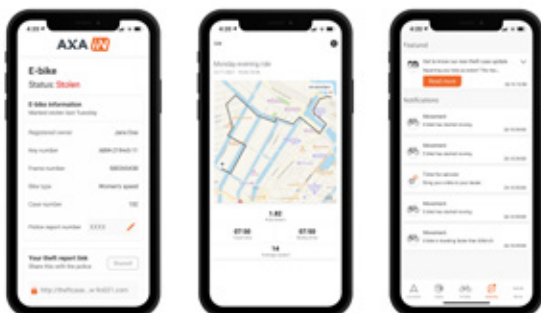

Connected customer

Stay in contact with the customer

The information which is now being collected from the consumer is of course very interesting for manufacturers. This offers a wealth of opportunities to stay in contact with customers, to offer advice and additional services quickly and easily. There is a dashboard on the computer available that includes information such as the distance ridden by each bike. A message can be easily sent via the app that maintenance is required or that the tires need to be replaced. This way you can stay in contact with your customers. By analyzing the collected data, future decisions or investments can be based on actual information.

The module and app are set up per brand and are designed to suit any style. This way your customer sees the brand identity every time he uses the app and feels more related to the brand.

Future

Further development of the module is in full swing. It will also be possible to send future software updates via the system or to offer a bike insurance quote. This means more customer convenience and additional revenue for the manufacturers. In addition to offering these additional services, it will be useful for gaining customer feedback on the quality of the bike. How often is the battery being charged? What is the reading of the temperature sensor? The performance of customer satisfaction surveys is also one of the future possibilities.

The benefits for both bike manufacturer and bike shop

- Customer data is displayed in the dashboard
- The ultimate way to stay in contact with your customers
- Very targeted services can be offered, such as maintenance and insurance
- Customer targeted promotions



Creating a more secure world, protecting what we value most

At Allegion, we understand how vulnerable the earth and the environment are, which is why we aim to reduce our environmental impact to a minimum with ambitious Environmental, Social and Governance targets.

Our ambitions

- All our locations should run on carbon-free electricity by 2030.
- We aim for a 25% reduction of our greenhouse gas emissions by 2030.
- We aim to be fully carbon neutral by 2040.



Sustainable development goals

We have selected six goals that are most relevant to our company and the three cornerstones of our sustainability strategy: Environment, Social and Governance (ESG).

We support the United Nations Sustainable Development Goals, which aim to make the world a better place. The 17 goals for 2030 have been agreed by all 196 United Nations (UN) member states, including the Netherlands.

Thousands of organisations and millions of citizens across the globe were asked to help define the SDGs.

- 1 SDG 3 Good health and well-being: ensure healthy lives and promote well-being for all at all ages.
- 2 SDG 5 Gender equality: achieve gender equality and empower all women and girls.
- 3 SDG 8 Decent work and economic growth: promote sustained, inclusive and sustainable economic growth, full and productive employment and decent work for all.
- 4 SDG 12 Responsible consumption and production: ensure sustainable consumption and production patterns.
- 5 SDG 13 Climate action: take urgent action to combat climate change and its effects.
- 6 SDG 17 Partnership to achieve the goals: strengthen the means of implementation and revitalise the global partnership for sustainable development.

Environmental

Expedition zero

Minimum footprint, zero waste – no wasting

Our planet is the only home we have, and we need to protect it together. That's why we're committed to reducing our environmental impact. We are taking steps to reduce our ecological footprint and to avoid wasting resources unnecessarily. Our offices and factory in Veenendaal (200 FTE) already run on 100% green electricity. Charging stations for electric cars are installed in our parking spaces.

Social

Because we care

Great place to work

We believe that our success is measured not just by our financial results, but also by the impact we have on the world around us. That's why we accept our responsibility to society. It means we are committed to protecting all those who use our products and all those who work for us by creating an inclusive workplace where everyone feels respected and valued.

“At Allegion, we’re dedicated to keeping people safe and secure while protecting the planet. Together, we can create a world where everyone can move seamlessly.”

John Stanley
Vice-president of Global Portable Security



Governance

Responsible citizen

Maximum impact - Partner of choice

As a socially responsible business, we understand that good governance is essential to the success of our company. We employ strict ethical and integrity standards in all our activities and we comply with all relevant legislation and regulations. We aim to make a positive impact on the world around us by embracing governance practices that promote sustainability and responsibility.

Get to
know more

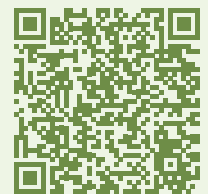

If you would like to find out more about our ambitions and targets on Environmental, Social and Governance subjects, please visit our website where there is more to be found. Scan the QR-code!

Bicycle lights

Allegion has a wide range of lighting products, from lights with which you can be seen, to lighting with plenty of light with which you have an excellent view of the road. For every bicycle and cyclist AXA and TRELOCK have the right lighting.

More than a dynamo

In addition to lighting powered by a dynamo Allegion also has lighting which can be connected directly on an E-bike battery, or has batteries by itself.

New in the assortment are our USB rechargeable lighting products, with which you never have to look for new batteries.

Lumen and Lux

The amount of light is measured with Lumen or Lux, but what is the difference?

With Lumen the amount of light is measured from the source per unit of time, regardless of where the light is radiated. With Lux they measure the amount of light that shines on a surface area, for example, on a square metre.

In this brochure we will use the amount of Lux per light.

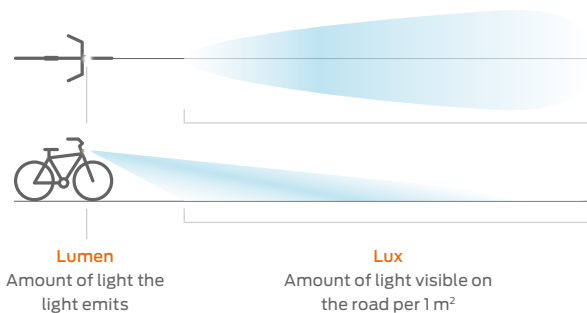

Daytime Running Light (DRL)

Depending on ambient brightness, a built-in light sensor chooses between Low Beam and DRL. The DRL has, thanks to special DRL LEDs, another light distribution which makes the cyclist more visible during the day for additional safety.

Visibility

Where does 'To see' and 'To be Seen' stand for?

When you are participating in traffic on your bike, it is just as important to be able 'to see' as it is to 'be seen' by other road users.

'To See' indicates how much you can see of the road with the lighting itself. These lights are mainly used by cyclists on poorly lighted roads so they have a good view of the road.

'To Be Seen' indicates from how many metres other road users can see you. This lighting is especially useful for cyclist in the city and on well-lit roads.

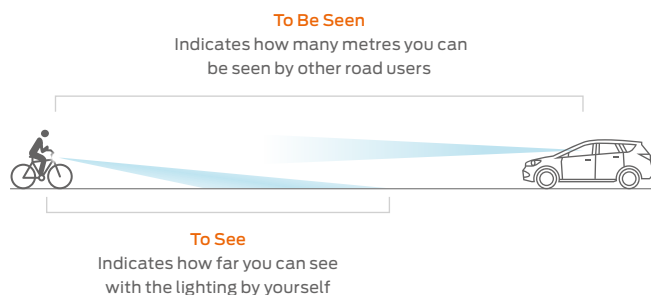

High Beam

High Beam has, compared to the usual Low Beam, a different Light Distribution thanks to additional LEDs. Similar to High Beam in the car, the light shines far more in the distance and does not have the characteristic cut-off line. That's why High Beam should only be activated if no other traffic participants can be blinded. Especially in very dark conditions or when cycling with high speed, High Beam is a very important safety feature for every cyclist. The High Beam Light can be activated via pushing on the handlebar switch.

Automatic function

The automatic function makes change of light the mode depending on ambient conditions like for example the ambient brightness.



Dynamo head lights

City and trekking bikes

ENTRY

TRELOCK
BIKE-i® RETRO 15
PAGE 54



AXA
Ecoline 15
PAGE 36



AXA
606 15
PAGE 38



AXA
Echo 15
PAGE 37



ENTRY

AXA
Ecoline 30
PAGE 39



AXA
Nxt 30
PAGE 40



PREMIUM

AXA
Nxt 45
PAGE 42



AXA
Nxt 60
PAGE 43



TRELOCK
Lighthammer 60
PAGE 44



TRELOCK
Lighthammer 80
PAGE 46





Dynamo rear lights

City and trekking bikes

ENTRY

AXA
Nyx serie
PAGE 59



AXA
Slim
PAGE 59



PREMIUM

TRELOCK
DUO FLAT
PAGE 60

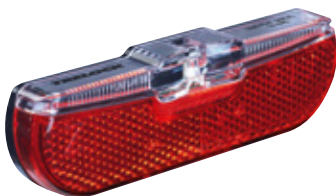

AXA
Juno
PAGE 60



AXA
Blueline
PAGE 61



ADVANCED

TRELOCK
COB LINE LS 41x
PAGE 61



TRELOCK
COB LINE LS 42x
PAGE 62



TRELOCK
COB LINE LS 65x
PAGE 62





E-Bike and S-Pedelec head lights

Directly powered by the battery

ENTRY

AXA
Ecoline 15
PAGE 36
6V



AXA
Echo 15
PAGE 37
6V



AXA
606 15
PAGE 38
6-48V



AXA
Ecoline 30
PAGE 39
6-12V



ENTRY

AXA
Nxt 30
PAGE 40
6-48V



TRELOCK
BIKE-i® RETRO 30
PAGE 54
6-12V



PREMIUM

AXA
Nxt 45
PAGE 42
6-12V



AXA
Nxt 60
PAGE 43
6-12V



PREMIUM

TRELOCK
Lighthammer 60
PAGE 44
6-12V



AXA
Nxt 80
PAGE 45
6-12V



TRELOCK
Lighthammer 80
PAGE 46
6-12V



ADVANCED

TRELOCK

Lighthammer 100

PAGE 47

12V



AXA

Nxt 130

PAGE 45

12V



TRELOCK

Lighthammer 130

PAGE 49

12V



TRELOCK

Lighthammer 150

PAGE 49

12V



ADVANCED

TRELOCK

Lighthammer

250 Premium

PAGE 52

12V



TRELOCK

Lighthammer

300

PAGE 52

12V



S-PED

E-Bike rear lights

Directly powered by the E-bike battery

ENTRY

AXA
Nyx serie
PAGE 59

6-12V



PREMIUM

TRELOCK
DUO FLAT
PAGE 60

6-12V



AXA
Juno
PAGE 60

6-12V | 6-48V



PREMIUM

AXA
BlueLine
PAGE 61

6-12V



ADVANCED

TRELOCK
COB LINE LS 41x
PAGE 61

6-12V



TRELOCK
COB LINE LS 42x
PAGE 62

6-12V



ADVANCED

TRELOCK
COB LINE LS 65x
PAGE 62

6-12V





Battery head lights

Including rechargeable lights

ENTRY

AXA
Visto 3 10
PAGE 66



AXA
706 15
PAGE 66



AXA
Classic 4
PAGE 66



AXA
Nox City 4
PAGE 67



ENTRY

AXA
Nox Sport 12
PAGE 67



PREMIUM

TRELOCK
Lighthammer serie
PAGE 70



AXA
Dwn serie
PAGE 71





AXA NOX-125A

Battery rear lights

Including rechargeable lights

ENTRY

AXA
Visto 3
PAGE 66



AXA
City Rear
PAGE 68



AXA
Run Compact
PAGE 68



AXA
Nyx serie
PAGE 59



PREMIUM

AXA
RIFF
PAGE 69



INCL.
LIGHT
GUIDE

TRELOCK
TRIO FLAT
PAGE 69



INCL.
LIGHT
GUIDE

AXA
Juno Battery
PAGE 68



ADVANCED

AXA
Dwn
PAGE 71

RECHARGEABLE

ⓘ
Brake
light



TRELOCK
I-GO® VECTOR REAR
PAGE 70

RECHARGEABLE



TRELOCK
I-GO® VECTOR
REAR SIGNAL
PAGE 70

RECHARGEABLE

ⓘ
Brake
light





Rear lights with brake lights function

Including rechargeable lights

PREMIUM

AXA

Juno
PAGE 60



ADVANCED

TRELOCK
COB LINE LS 41x
PAGE 61

6-12V



TRELOCK
COB LINE LS 42x
PAGE 62

6-12V



ADVANCED

TRELOCK
COB LINE LS 65x
PAGE 62

6-12V



TRELOCK
I-GO® VECTOR REAR SIGNAL
PAGE 70

RECHARGEABLE



AXA
Dwn
PAGE 71

RECHARGEABLE





AXA

Ecoline 15



Integrated reflector

**15
LUX**

StVZO

**French
APPROVAL**

**35
METERS**
▲

**2250
METERS**
▲



The AXA Ecoline 15 is a basic dynamo headlight with a light output of 15 Lux. The Ecoline 15 offers a combination of an integrated reflector with optimal light distribution. Both features enhance the safety aspect, as you are better seen by other traffic and the road in front of you is well lighted.

AXA Ecoline 15

Type	E-Bike	Hub/side dynamo	
Art. no.	92640095	92631095	92641095
LUX	15 LUX	15 LUX	
Watt		1,2 W	2,4 W
Field of vision	35 m	35 m	
Visibility	2250 m	2250 m	
Switch			
Steady			
Auto On/Off			
Day time safety			
Source	6V DC	Hub/Side	
Wire	10 cm	60 cm	
Rear light connection		■	

■ Standard Custom adaptations possible

AXA

Echo 15

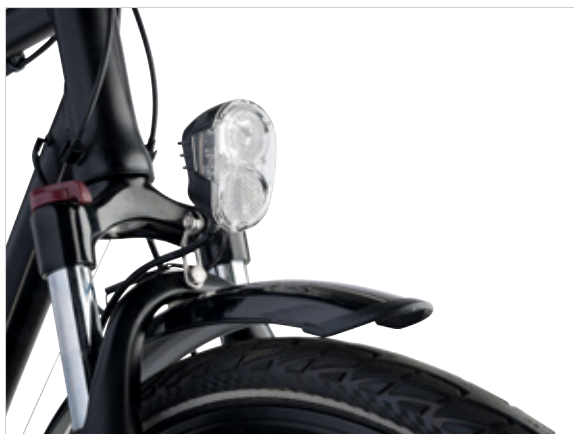

Integrated reflector



15
LUX

StVZO

French
APPROVAL

35
METERS
▲

2250
METERS
▲

The AXA Echo 15 is an universal dynamo headlight with a light output of 15 Lux.

The Echo 15 offers a combination of an integrated reflector with optimal light distribution. Both features enhance the safety aspect, as you are better seen by other traffic and the road in front of you is well lit.

The steady function makes also sure that you are seen while standing still.

The robust stainless steel bracket can be replaced for one of the specially designed brackets for semi integration with the most common front forks.

AXA Echo 15

Type	E-Bike	Switch	Steady	Steady Auto
Art. no.	91006095	91026095	91016095	91086095
LUX	15 LUX	15 LUX	15 LUX	15 LUX
Field of vision	35 m	35 m	35 m	35 m
Visibility	2250 m	2250 m	2250 m	2250 m
Switch		■	■	■
Steady			■	■
Auto On/Off				■
Day time safety				
Source	6V DC	Hub/Side	Hub/Side	Hub/Side
Wire	10 cm	60 cm	60 cm	60 cm
Rear light connection		■	■	■

■ Standard Custom adaptations possible

AXA

606 15



Integrated reflector

15
LUX

StVZO

35
METERS
▲

2250
METERS
▲

The AXA 606 15 is a classic dynamo headlight with a light output of 15 Lux. The 606 offers a combination of an integrated reflector with optimal light distribution. Both features enhance the safety aspect, as you are better seen by other traffic and the road in front of you is well lighted.

AXA 606 15

Type	E-Bike	Auto	Steady Auto
Art. no.	92915396	92915196	92915296
LUX	15 LUX	15 LUX	15 LUX
Field of vision	35 m	35 m	35 m
Visibility	2250 m	2250 m	2250 m
Switch		■	■
Steady			■
Auto On/Off		■	■
Day time safety			
Source	6-48V	Hub/Side	Hub/Side
Wire	10 cm	60 cm	60 cm
Rear light connection		■	■

■ Standard Custom adaptations possible

AXA

Ecoline 30



Integrated reflector



The AXA Ecoline 30 is a basic dynamo headlight with a light output of 30 Lux. The Ecoline 30 offers a combination of an integrated reflector with optimal light distribution. Both features enhance the safety aspect, as you are better seen by other traffic and the road in front of you is well lit.

AXA Ecoline 30

Type	E-Bike	Hub/side dynamo
Art. no.	926950	926855
LUX	30 LUX	30 LUX
Watt		2,4 W
Field of vision	50 m	50 m
Visibility	3000 m	3000 m
Switch		
Steady		■
Auto On/Off		
Day time safety		
Source	6-12V DC	Hub/Side
Wire	10 cm	60 cm
Rear light connection		■

■ Standard Custom adaptations possible

AXA

Nxt 30



Integrated reflector

30
LUX

StVZO

French
APPROVAL

50
METERS
▲

3000
METERS
▲



The new AXA Light with 30 Lux impresses with an extensive light pattern on the road which makes sure you will have good visibility for a safe ride. For extra safety the steady light function in the dynamo version ensures that you are seen for 4 minutes when standing still.

Besides the landscape orientation - which is a perfect design match to bikes with increasing frame, stem and handlebar dimensions - the design is subtle to keep the attention on the bike, not on the light.

The new fork bracket is a perfect design match for the new AXA light design, making sure the light will look well integrated to the bike. The product design is also very well suitable for handlebar mounting via faceplate solutions or handlebar brackets.

AXA Nxt 30

Type	E-Bike	Steady
Art. no.	91900095	91920095
LUX	30 Lux	30 Lux
Field of vision	50 m	50 m
Visibility	3000 m	3000 m
Switch		■
Steady		■
Automatic function		
Day time safety		
Source	6-48V DC	Hub/Side
Wire	10 cm	60 cm
Rear light connection		■
Mount position	Fork/Handlebar	Fork/Handlebar

■ Standard Custom adaptations possible

Scan and watch the video





AXA

Nxt 45



Integrated reflector



45
LUX

StVZO

French
APPROVAL

65
METERS
▲

3750
METERS
▲

The new AXA Light with 45 Lux impresses with an extensive light pattern on the road which makes sure you will have good visibility for a safe ride. For extra safety the steady light function in the dynamo version ensures that you are seen for 4 minutes when standing still.

Besides the landscape orientation - which is a perfect design match to bikes with increasing frame, stem and handlebar dimensions - the design is subtle to keep the attention on the bike, not on the light.

The new fork bracket is a perfect design match for the new AXA light design, making sure the light will look well integrated to the bike. The product design is also very well suitable for handlebar mounting via faceplate solutions or handlebar brackets.

AXA Nxt 45

Type	E-Bike	Steady
Art. no.	91950095	91970095
LUX	45 Lux	45 Lux
Field of vision	65 m	65 m
Visibility	3750 m	3750 m
Switch		■
Steady		■
Automatic function		
Day time safety		
Source	6-12V DC	Hub/Side
Wire	10 cm	60 cm
Rear light connection		■
Mount position	Fork/Handlebar	Fork/Handlebar

■ Standard Custom adaptations possible

Scan and watch the video



AXA

Nxt 60



Handlebar bracket for E-Bike

60
LUX

StVZO

French
APPROVAL

80
METERS
▶

4500
METERS
▶

The new AXA Light with 60 Lux impresses with an extensive light pattern on the road which makes sure you will have good visibility for a safe ride. For extra safety the steady light function in the dynamo version ensures that you are seen for 4 minutes when standing still.

Besides the landscape orientation - which is a perfect design match to bikes with increasing frame, stem and handlebar dimensions - the design is subtle to keep the attention on the bike, not on the light.



The new fork bracket is a perfect design match for the new AXA light design, making sure the light will look well integrated to the bike. The product design is also very well suitable for handlebar mounting via faceplate solutions or handlebar brackets.

AXA Nxt 60

Type	E-Bike	Steady
Art. no.	92500095	92520095
LUX	60 Lux	60 Lux
Field of vision	80 m	80 m
Visibility	4500 m	4500 m
Switch		■
Steady		■
Automatic function		
Day time safety		
Source	6-12V DC	Hub/Side
Wire	10 cm	60 cm
Rear light connection		■
Mount position	Fork/Handlebar	Fork/Handlebar

■ Standard Custom adaptations possible

Scan and watch the video



TRELOCK

Lighthammer 60



Handlebar bracket for E-Bike



60
LUX

StVZO

French
APPROVAL

80
METERS

4500
METERS

The Trelock Lighthammer with 60 Lux impresses with an extensive light pattern on the road which, besides being very wide and homogenous, ensures best illumination both in the distance as well as close in front of the bike.

For best safety during the day, the Dynamo version is available with day time running light including automatic function. The steady light ensures to be seen by other road users even when standing still. The unique edgy design with landscape orientation

is still impressively compact and expresses the high light performance. It is a perfect design match to bikes with increasing frame, stem and handlebar dimensions. Thanks to the special housing version offered for mounting e-bike lights to the handlebar via the dedicated bracket or faceplate solutions, the light looks perfectly integrated into the overall bike design.

The extended scatter glass integrates nicely to the side of housing and increases safety by the high visibility of the cyclist from the side.

TRELOCK Lighthammer 60

Type	LS 800 E-Bike	LS 805-T
Art. no	8006094	8006095
LUX	60 Lux	60 Lux
Field of vision	80 m	80 m
Visibility	4500 m	4500 m
Switch		■
Steady		■
Automatic function		■
Day time safety		■
Source	6-12V DC	Hub/Side
Wire	10 cm	60 cm
Rear light connection		■
Mount position	Fork/Handlebar	Fork/Handlebar

■ Standard Custom adaptations possible

Scan and watch the video



AXA

Nxt 80



Handlebar bracket for E-Bike

80
LUX

StVZO

French
APPROVAL

100
METERS
▲

5500
METERS
▲

The new AXA Light with 80 Lux impresses with an extensive light pattern on the road which makes sure you will have good visibility for a safe ride. For extra safety the steady light function in the dynamo version ensures that you are seen for 4 minutes when standing still.

Besides the landscape orientation - which is a perfect design match to bikes with increasing frame, stem and handlebar dimensions - the design is subtle to keep the attention on the bike, not on the light.

AXA Nxt 80

Type	E-Bike
Art. no.	92550095
LUX	80 Lux
Field of vision	100 m
Visibility	5500 m
Switch	
Steady	
Automatic function	
Day time safety	
Source	6-12V DC
Wire	10 cm
Rear light connection	
Mount position	Fork/Handlebar

■ Standard Custom adaptations possible



The new fork bracket is a perfect design match for the new AXA light design, making sure the light will look well integrated to the bike. The product design is also very well suitable for handlebar mounting via faceplate solutions or handlebar brackets.

Scan and watch the video



TRELOCK

Lighthammer 80



Handlebar bracket for E-Bike



80
LUX

StVZO

French
APPROVAL

100
METERS

5500
METERS

The Trelock Lighthammer with 80 Lux impresses with an extensive light pattern on the road which, besides being very wide and homogenous, ensures best illumination both in the distance as well as close in front of the bike.

For best safety during the day, the E-Bike and Dynamo versions are available with day time running light including automatic function. The steady light in the Dynamo Version ensures to be seen by other road users even when standing still.

The unique edgy design with landscape orientation is still impressively compact and expresses the high light performance. Thanks to the special housing version offered for mounting e-bike lights to the handlebar via the dedicated bracket or faceplate solutions, the light looks perfectly integrated into the overall bike design.

The extended scatter glass integrates nicely to the side of housing and increases safety by the high visibility of the cyclist from the side.

TRELOCK Lighthammer 80

Type	LS 830 E-Bike	LS 830-T E-Bike	LS 835-T
Art. no	8006096	8006097	8006098
LUX	80 Lux	80 Lux	80 Lux
Field of vision	100 m	100 m	100 m
Visibility	5500 m	5500 m	5500 m
Switch			■
Steady			■
Automatic function		■	■
Day time safety		■	■
Source	6-12V DC	6-12V DC	Hub/Side
Wire	10 cm	10 cm	60 cm
Rear light connection			■
Mount position	Fork/Handlebar	Fork/Handlebar	Fork/Handlebar

■ Standard Custom adaptations possible

Scan and watch the video



TRELOCK

Lighthammer 100



Handlebar bracket for E-Bike

100
LUX

StVZO

HIGH
BEAM

120
METERS
◀

6500
METERS
▶



The Trelock Lighthammer with 100 Lux impresses with an extensive light pattern on the road which, besides being very wide and homogenous, ensures best illumination both in the distance as well as close in front of the bike.

For best safety during the day, the front light is available with day time running light including automatic function.

The new high beam mode of impressive 130 Lux allows maximum visibility in the long distance and

makes the ride even more comfortable.

The unique edgy design with landscape orientation is still impressively compact and expresses the high light performance. Thanks to the special housing version offered for mounting e-bike lights to the handlebar via the dedicated bracket or faceplate solutions, the light looks perfectly integrated into the overall bike design.

The extended scatter glass integrates nicely to the side of housing and increases safety by the high visibility of the cyclist from the side.

TRELOCK Lighthammer 100

Type	LS 890-T E-Bike	LS 890-HB E-Bike	LS 890 E-Bike
Art. no	8006099	8006100	8006165
LUX	100 Lux	100 Lux	100 Lux
High Beam		130 Lux	
Field of vision	120 m	120 m	120 m
Visibility	6500 m	6500 m	6500 m
Automatic function	■		
Day time safety	■		
Housing material	Aluminum	Aluminum	Aluminum
Source	12V DC	12V DC	12V DC
Wire	10 cm	10 cm	10 cm
Approval	StVZO	StVZO	StVZO, French approval
Mount position	Fork/Handlebar	Fork/Handlebar	Fork/Handlebar

■ Standard Custom adaptations possible

Scan and watch the video



AXA

Nxt 130



Integrated reflector

130
LUX

StVZO

140
METERS

7000
METERS

The AXA Nxt 130 is an E-bike headlight with a light output of 130 lux and is specially designed to be directly connected to a 12V DC E-bike battery. The housing is made entirely of aluminum, which ensures optimal heat dissipation.

The front light has a compact, square design that perfectly matches the geometry of E-bikes! The integrated reflector provides extra safety as it makes you more visible to oncoming traffic.



The light pattern of the Nxt 130 is the best that AXA has introduced to the market so far. This is due to the very wide beam that covers the entire street and the good amount of light directly in front of the bike.

The headlight comes with a bracket so you can mount it on the front fork of the bike. It fits on all standard forks. This bracket can be replaced by a single-arm aluminum handlebar bracket so you can mount the light under the E-bike computer.

AXA Nxt 80

Type	E-Bike
LUX	130 Lux
Field of vision	140 m
Visibility	7000 m
Switch	
Steady	
Automatic function	
Day time safety	
Source	12V DC
Wire	10 cm
Rear light connection	
Mount position	Fork/Handlebar

■ Standard Custom adaptations possible

Scan and watch the video



TRELOCK

Lighthammer 130



Handlebar bracket for E-Bike

130
LUX

StVZO

HIGH
BEAM

160
METERS
▲

7000
METERS
▲



The Trelock Lighthammer with 130 Lux impresses with an extensive light pattern on the road which, besides being very wide and homogenous, ensures best illumination both in the distance as well as close in front of the bike.

For best safety during the day, the front light is available with day time running light including automatic function.

The new high beam mode of impressive 150 Lux allows maximum visibility in the long distance and make the ride even more comfortable.

The unique edgy design with landscape orientation expresses the high light performance and make the light look premium and integrated, both on fork and handlebar.

The extended scatter glass integrates nicely to the side of the high-quality aluminium housing and increases safety by the high visibility of the cyclist from the side.

TRELOCK Lighthammer 130

Type	LS 930-T E-Bike	LS 930-HB E-Bike
Art. no	8006101	8006102
LUX	130 Lux	130 Lux
High Beam		150 Lux
Field of vision	140 m	160 m
Visibility	7000 m	7000 m
Automatic function	■	
Day time safety	■	
Housing material	Aluminum	Aluminum
Source	12V DC	12V DC
Wire	10 cm	10 cm
Rear light connection		
Mount position	Handlebar/Fork	Handlebar/Fork

■ Standard Custom adaptations possible

Scan and watch the video



TRELOCK

Lighthammer 150



Handlebar bracket for E-Bike



150
LUX

StVZO

HIGH
BEAM

150
METERS

7250
METERS

The Trelock Lighthammer with 150 Lux impresses with an extensive light pattern on the road which, besides being very wide and homogenous, ensures best illumination both in the distance as well as close in front of the bike.

For best safety during the day, the front light is available with day time running light including automatic function.

The new high beam mode of impressive 150 Lux allows maximum visibility in the long distance and make the ride even more comfortable.

The unique edgy design with landscape orientation expresses the high light performance and make the light look premium and integrated, both on fork and handlebar.

The extended scatter glass integrates nicely to the side of the high-quality aluminium housing and increases safety by the high visibility of the cyclist from the side.

TRELOCK Lighthammer 150

Type	LS 940-HB E-Bike
LUX	150 Lux
High Beam	150 Lux
Field of vision	150 m
Visibility	7250 m
Automatic function	■
Day time safety	■
Housing material	Aluminum
Source	12V DC
Wire	10 cm
Rear light connection	
Mount position	Handlebar/Fork

■ Standard Custom adaptations possible

Scan and watch the video





TRELOCK

Lighthammer Premium



Handlebar bracket for E-Bike

**300
LUX**

StVZO

HIGH
BEAM

S-PED

120
METERS
▲

6500
METERS
▲

The road has never been brighter: the low beam of the LIGHTHAMMER PREMIUM puts a full 200 lux on the asphalt! If even more visibility is needed, the high beam mode with up to 300 lux can be switched on using the handlebar control. With the powerful light output of the headlight, correct alignment is particularly important. A Level Function is integrated into the LIGHTHAMMER PREMIUM to help with correct adjustment. During the day, the cyclist is assisted by a clearly visible Daytime Running Light.

Thanks to a sensor, there is automatic switching between daytime running light and low beam. Environmental considerations are also taken into account: in order to conserve the battery with the high output, the headlamp switches to Waiting Mode (can be turned on and off) when the bicycle is at a standstill. The light output is reduced by 50% until the bike moves again. The LIGHTHAMMER PREMIUM is available as an e-bike version and as a version for S-pedelegs.

TRELOCK Lighthammer Premium

Type	LS 990 250 E-Bike	LS 990 300 S-Ped
Art. no	8006210	8006211
LUX	200 Lux	200 Lux
High Beam	250 Lux	300 Lux
Field of vision	170 m	170 m
Visibility	8000 m	8000 m
Automatic function	■	■
Daytime Running Light	■	■
Housing material	Aluminum	Aluminum
Source	12V DC	12V DC
Wire	10 cm	10 cm
Rear light connection		
Mount position	Fork/Handlebar	Fork/Handlebar

■ Standard Custom adaptations possible



TRELOCK

BIKE-i® RETRO



Integrated reflector

15 LUX	StVZO	35 METERS	2250 METERS
30 LUX	StVZO	50 METERS	3000 METERS

Nostalgia meets modern – classic fanciers who love the edge design and catchy forms from the early times, will be send with the TRELOCK RETRO-line back to the past, but not without the disclaimer of todays technologies and modern security standards. Back to the 50's? No problem with the TRELOCK RETRO-line.

Available in classic black or stylish chrome, the BIKE-i® retro captivates with 15 Lux/30Lux, a range of vision of 35 metres/50 metres. Automatic standlight function, reflector and on/off switch add to the comfort.

TRELOCK BIKE-i® RETRO

Type	LS 580 E-Bike		LS 582		LS 583	
Art. no.	8005098	8005064	8003445	8003446	8003447	8003448
Colour	Black	Chrome	Black	Chrome	Black	Chrome
LUX	30 LUX		15 LUX		15 LUX	
Field of vision	50 m		35 m		35 m	
Visibility	3000 m		2250 m		2250 m	
Switch			■		■	
Steady					■	
Auto On/Off						
Day time safety						
Source	6 –12V DC		Hub/Side		Hub/Side	
Wire	60 cm		60 cm		60 cm	
Rear light connection	■		■		■	

■ Standard Custom adaptations possible



Front light brackets

City and trekking bikes

STANDARD



FOR ALL TRELOCK HEAD LIGHTS
TRELOCK
ZL 810
8002122



FOR ALL TRELOCK HEAD LIGHTS
TRELOCK
AXA
ZL 830
8002124



FOR ALL TRELOCK HEAD LIGHTS
TRELOCK
AXA
ZL 840
8002125



FOR ALL TRELOCK HEAD LIGHTS
TRELOCK
AXA
ZL 850
8003453



FOR ALL TRELOCK HEAD LIGHTS
TRELOCK
AXA
ZL 860
8004123



FOR ALL TRELOCK HEAD LIGHTS
TRELOCK
ZL 940
8005214

STANDARD



FOR ALL TRELOCK HEAD LIGHTS
TRELOCK
ZL 990
8005221



FOR BLUELINE 30
COMPACTLINE 20
AXA
BlueLine/
Compactline
CR8



FOR BLUELINE 50
COMPACTLINE 35
AXA
BlueLine/
Compactline
CR8



FOR ECHO/PICO
AXA
Echo/
Pico CR8



FOR ECHO/PICO
AXA
Echo/
Pico CR9

SUNTOUR

SUNTOUR



FOR ALL TRELOCK HEAD LIGHTS
TRELOCK
ZL SR 870
CR8
8002127



FOR ALL TRELOCK HEAD LIGHTS
TRELOCK
ZL SR 970
CR8
8004057



FOR ALL TRELOCK, COMPACTLINE HEAD LIGHTS
TRELOCK
AXA
MOBIE
8005216 TRELOCK



FOR ALL TRELOCK, COMPACTLINE HEAD LIGHTS
TRELOCK
AXA
ZL 995
MOBIE 2 AXIS
8005550 TRELOCK



FOR ALL TRELOCK, COMPACTLINE HEAD LIGHTS
TRELOCK
AXA
ZL 955
MOBIE Head
Tube
8005555 TRELOCK

SRAM/PARAGON



FOR ALL TRELOCK,
COMPACTLINE
HEAD LIGHTS

TRELOCK
AXA
SRAM/
PARAGON
8005011 TRELOCK

HANDLE BAR



FOR ALL TRELOCK
HEAD LIGHTS

TRELOCK
AXA
ZL HB 100
8005010



FOR LIGHTHAMMER
AND NXT

TRELOCK
AXA
ZL HB 400
Ø 25,4 mm
8006119 TRELOCK



FOR LIGHTHAMMER
AND NXT

TRELOCK
AXA
ZL HB 400
Ø 31,8 mm
8006120 TRELOCK



FOR LIGHTHAMMER
AND NXT

TRELOCK
AXA
ZL HB 400
Ø 35 mm
8006121 TRELOCK

FORK



FOR LIGHTHAMMER
AND NXT

TRELOCK
AXA
ZL 410
8006122 TRELOCK

FACEPLATE ADAPTER



FOR LIGHTHAMMER
AND NXT

TRELOCK
AXA
ZL 430
8006123 TRELOCK

FOX



FOR ALL TRELOCK/
AXA HEAD LIGHTS

TRELOCK
AXA
FOX AWL
8006162 TRELOCK

SADDLE



50 MM MOUNTING REAR LIGHTS/REFLECTOR

TRELOCK
AXA
ZL 440 Saddle bracket
900200 AXA
TRELOCK

GOPRO



GOPRO ADAPTER

TRELOCK
AXA
Go Pro bracket
900660 AXA
8006255 TRELOCK



AXA NYX-EG-12 V

AXA

Nyx



AXA Nyx

Type	E-Bike		Steady
Art. no	93192095	93193095	93194095
Mounting distance	Fender/Rear Stay		Fender/Rear Stay
LED	■	■	■
Brake light function		■	
Visibility	500 m		500 m
Light guide			
Steady			■
Source	E-bike battery 6-12 V		Hub/Side

■ Standard Custom adaptations possible



ZL 630

Type Bracket for all fender rear lights

Art. no. 8003872

AXA

Slim



AXA Slim

Type	E-Bike			
Art. no	93098095	93099095	93093095	93094095
Mounting distance	50 mm	80 mm	50 mm	80 mm
Connectivity	faston		push	
LED			■	
Brake light function				
Visibility	500 m			
Light guide				
Source	E-bike battery 6V			

■ Standard Custom adaptations possible

TRELOCK

DUO FLAT

StVZO French APPROVAL 600 METERS Z REFLECTOR



TRELOCK DUO FLAT

Type	LS 611 E-BIKE		LS 613	
Art. no.	8004927	8005035	8002751	8002819
Mounting distance	50 mm	80 mm	50 mm	80 mm
LED	■			■
Brake light function				
Visibility	600 m		600 m	
Light guide	■			■
Steady				■
Source	6V - 12 V DC		Hub/Side	

■ Standard Custom adaptations possible

AXA

Juno

Brake light 500 METERS Z REFLECTOR StVZO French APPROVAL



AXA Juno

Type	E-bike			E-bike Signal			E-bike 6-48V <small>NEW</small>		Steady		
Art. no.	91840095	91841095	91840595	91840195	91841195	91840795	91840895	91840995	91845095	91846095	91845595
Mounting distance in mm	50	80	50/80*	50	80	50/80*	50	80	50	80	50/80*
LED		■			■			■			■
Brake light function					■						
Visibility	500 m			500 m			500 m		500 m		
Steady											■
Source	6-12 V			6-12 V			6-48 V		Hub/Side		

■ Standard Custom adaptations possible *Self-tapping

AXA

Blueline



AXA Blueline

Type	E-Bike		E-bike		Steady	
Art. no	93110095	93115095	93110795	93115795	93120095	93125095
Mounting distance	50 mm	80 mm	50 mm	80 mm	50 mm	80 mm
LED	■		■		■	
Brake light function						
Visibility	600 m		600 m		600 m	
Light guide	■		■		■	
Steady					■	
Source	E-bike battery 6V		E-bike battery 6-12 V		Hub/Side	

■ Standard Custom adaptations possible

TRELOCK

COB LINE LS 41x



TRELOCK COB LINE LS 41x (Fender)

Type	LS 411 E-Bike	LS 414 E-Bike Signal	LS 413 Dynamo	LS 415 Dynamo Signal
Art. no.	8005562	8005563	8005564	8005565
Start-up sequence	■	■		
Steady			■	■
Brake light function		■		■
Connection	10 cm cable with faston	10 cm cable with faston	10 cm cable with faston	10 cm cable with faston
Mounting	Fender / Seat Stay with bracket ZL 630	Fender / Seat Stay with bracket ZL 630	Fender / Seat Stay with bracket ZL 630	Fender / Seat Stay with bracket ZL 630
Power Source	E-Bike 6-12V DC	E-Bike 6-12V DC	Dynamo	Dynamo

■ Standard Custom adaptations possible

TRELOCK

COB LINE LS 42x









ADVANCED

TRELOCK COB LINE LS 42x (Integrated fender rear light)

Type	LS 421 E-Bike	LS 424 E-Bike Signal	LS 423 Dynamo
Art. no.	8005566	8005567	8005568
Start-up sequence	■	■	
Steady			■
Brake light function		■	
Connection	10 cm cable with faston	10 cm cable with faston	10 cm cable with faston
Mounting	Integration	Integration	Integration
Power Source	E-Bike 6-12V DC	E-Bike 6-12V DC	Dynamo

■ Standard Custom adaptations possible

Scan and watch the video



ADVANCED

TRELOCK

COB LINE LS 65x









NEW

Reflector ZL 650
Available separately

- Z-Reflector
- StVZO Approved
- Self tapping screws
- Very compact in size
- 50 mm variant

Art. no.
8005501

TRELOCK COB LINE LS 65x (Carrier)

Type	LS 651 E-Bike	LS 654 E-Bike Signal	LS 653 Dynamo	LS 655 Dynamo Signal
Art. no.	8005558	8005559	8005560	8005561
Mounting distance	50 mm	50 mm	50 mm	50 mm
Start-up sequence	■	■		
Steady			■	■
Brake light function		■		■
Connection	10 cm cable with faston	10 cm cable with faston	10 cm cable with faston	10 cm cable with faston
Z Reflector	Optional	Optional	Optional	Optional
Power Source	E-Bike 6-12V DC	E-Bike 6-12V DC	Dynamo	Dynamo

■ Standard Custom adaptations possible

Scan and watch the video



Reflectors

City and trekking bikes



AXA

AXA Rear Reflector

Type	Rear Reflector
Art. no.	93196695
Mounting distance	Fender/Rear Stay
Housing colour	Black/red housing
Approvals	"Z" ECE IA



TRELOCK

TRELOCK ZL 620

Type	Rear Reflector
Art. no.	8005501
Mounting distance	Carrier 50 or 80 mm
Housing colour	Black/red housing
Approvals	"Z" ECE IA



TRELOCK

TRELOCK ZL 650

Type	Rear Reflector
Art. no.	8006042
Mounting distance	Carrier 50 mm
Housing colour	Black/red housing
Approvals	"Z" ECE IA

AXA

Visto 3 Set



Integrated reflector

10 LUX

StVZO

French APPROVAL

30 METERS

2000 METERS

300 METERS

Z REFLECTOR

The Visto 3 battery light set is user-friendly and fits seamlessly and easy onto any bike. Designed and manufactured in Europe. New regulations Compliant with the latest French, German and Danish regulations, the Visto 3 light set ensures safe and legal bicycle lighting. Powerful and safe illumination.

The lights are powered by larger AAA batteries, not only eliminating the risk associated with Coin Cell CR2032 batteries - which can be hazardous if swallowed by children - but also extending the battery life.

AXA Visto 3 Set

Type	Front	Rear
LUX	10 LUX	2,5 Cd
Housing colour	Black	Black
Battery type	2 AAA batteries	1 AAA batteries
Battery run-time	up to 7 h	up to 8 h
Visibility	2000 m	300 m
Field of vision	30 m	
Battery indicator	■	■

■ Standard



AXA

706

15
LUX



AXA 706

Type	706
Art. no.	92912096 SC
LUX	15 LUX
Housing colour	Dark chrome
Integrated retro reflector	■
Battery type	4 AAA batteries
Battery run-time	up to 50 h
Visibility	2250 m
Field of vision	35 m
Battery indicator	

■ Standard

AXA

Classic battery

4
LUX



AXA Classic

Type	Classic Black	Classic Silver
Art. no.	92911095	92910096
LUX	4 LUX	4 LUX
Housing colour	Black (mat)	Silver (chrome)
Battery type	3 AAA batteries	3 AAA batteries
Battery run-time	up to 50 h	up to 50 h
Visibility	1000 m	1000 m
Field of vision	15 m	15 m
Battery indicator	■	■

■ Standard



Black



Silver

AXA

Nox City

4
LUX

French
APPROVAL

AXA Nox City

Type	Nox City
Art. no.	92241195
LUX	4 LUX
Housing colour	Black
Battery type	2 AA batteries
Battery run-time	up to 40 h
Visibility	1000 m
Field of vision	15 m
Battery indicator	■
Turns off automatically	

■ Standard



AXA

Nox Sport

4
LUX

12
LUX

French
APPROVAL

AXA Nox Sport

Type	Sport City	Sport City	Nox Sport Auto off
Art. no.	92251195	92251395	92251495
LUX	4 LUX	12 LUX	12 LUX
Housing colour	Black	Black	Black
Battery type	2 AA batteries	2 AA batteries	2 AA batteries
Battery run-time	up to 40 h	up to 24 h	up to 24 h
Visibility	1000 m	2000 m	2000 m
Field of vision	15 m	30 m	30 m
Battery indicator	■	■	■
Turns off automatically			■

■ Standard



Battery rear lights

City and trekking bikes



AXA

AXA City rear

ENTRY

Type	City rear
Art. no.	93160095
Mounting distance	50 or 80 mm
Housing colour	Black/red housing
Battery type	2 AAA batteries
Battery run-time	up to 50 h
Visibility	500 m
Battery indicator	■

■ Standard

AXA

AXA Run Compact

ENTRY

Type	Run Compact Battery
Art. no.	93170595
Mounting distance	Fender
Housing colour	Black/red housing
Battery type	2 AAA batteries
Battery run-time	up to 50 h
Visibility	500 m
Battery indicator	■

■ Standard Custom adaptations possible



AXA

AXA Juno Battery

PREMIUM

Type	Juno		Juno Auto off	
Art. no.	91850095	91850595	91851095	91851595
Mounting distance	50 mm	80 mm	50 mm	80 mm
Housing colour	Black/red housing		Black/red housing	
Battery type	2 AAA batteries		2 AAA batteries	
Battery run-time	up to 50 h		up to 50 h	
Visibility	500 m		500 m	
Battery indicator	■		■	
Turns off automatically			■	

■ Standard Custom adaptations possible

Bike Lights - Battery Rear Lights



AXA AXA Riff

PREMIUM

Type	Riff	
Art. no.	93030195	93035195
Mounting distance	50 mm	80 mm
Housing colour	Black/red housing	
Battery type	2 AA batteries	
Battery run-time	up to 100 h	
Visibility	600 m	
Battery indicator	■	

■ Standard Custom adaptations possible



TRELOCK TRELOCK TRIO FLAT

PREMIUM

Type	LS 812
Art. no.	8002307
Mounting distance	50 or 80 mm
Housing colour	Black/red housing
Battery type	2 AA batteries
Battery run-time	up to 65 h
Visibility	600 m
Battery indicator	■

■ Standard Custom adaptations possible

TRELOCK

Lighthammer



LS 440 LIGHTHAMMER

40 LUX StVZO

LS 480 LIGHTHAMMER

80 LUX StVZO



TRELOCK i-GO® VECTOR Rear light

Type	LS 740 i-GO® Vector Rear	LS 740 i-GO® Vector Rear Signal
Art. no.	8005407	8005406
Modes	2 Levels	2 Levels
Battery run-time	up to 10 h	up to 10 h
Visibility	500 m	500 m
Battery indicator	■	■
USB-rechargeable	■	■
Brake light function		■

TRELOCK Lighthammer Sets

Type	LS 440 Set	LS 480 Set
Art. no.	8006201	8006202
Front	LS 440 Lighthammer	LS 480 Lighthammer
Rear	LS 740 i-GO® Vector rear	LS 740 i-GO® Vector rear signal

TRELOCK Lighthammer Front lights

Type	LS 440	LS 480
Art. no.	8006205	8006206
LUX	40 LUX	80 LUX
Modes	2 levels	3 Levels
USB-rechargeable	■	■
Battery run-time	up to 10 h	up to 15 h
Visibility	3500 m	5500 m
Field of vision	60 m	100 m
Battery indicator	■	■
Bracket	Silicon Strap	Silicon Strap Upside Down mounting possible

■ Standard

AXA Dwn



Dwn 30

**30
LUX**

StVZO

Dwn 50

**50
LUX**

StVZO

Dwn 70

**70
LUX**

StVZO

Dwn 100

**100
LUX**

StVZO

**Brake
light**

StVZO



AXA Dwn Rear lights

Type	Dwn R	Dwn RS
Art. no.	93958895 CB	93958995 CB
Brake light function		■
USB-rechargeable	■	■
Battery run-time	up to 7 h	up to 7 h
Visibility	300 m	300 m
Battery indicator	■	■

AXA Dwn Front lights

Type	Dwn 100	Dwn 70	Dwn 50	Dwn 30
Art. no.	93958495 CB	93958395 CB	93958295 CB	93958195 CB
LUX	100 LUX	70 LUX	50 LUX	30 LUX
Modes	4 levels	3 levels	3 levels	2 levels
USB-rechargeable	■	■	■	■
Battery run-time	up to 20 h	up to 20 h	up to 11 h	up to 11 h
Visibility	6500 m	5000 m	4000 m	3000 m
Field of vision	120 m	90 m	70 m	50 m
Side visibility				
Battery indicator	■	■	■	■

■ Standard



Bike locks

With its bike lock solutions, Allegion offers customers more than just security for their bicycles. Innovative additional solutions provide the cyclist with increased security and convenience. Modern cylinder technology and high quality materials provide reliable bicycle locks and as an added plus also reduce the weight of the lock.

Any lock for any biker

The number of bicycle thefts is on the increase and only every tenth bicycle is eventually returned to its original owner. However, cyclists investing in a good lock reduce the risk of their bicycle being stolen.

Allegion bicycle locks offer an adequate amount of security for every opportunity. Using the right lock can contribute to minimizing the risk of bicycle theft.

Reducing bike theft

Approvals

To reduce the chance of getting your bicycle stolen there are independent institutes that approve locks set the objective to promote and improve anti theft products. They test various locks to the requirements so that they can receive a quality label. An approved lock does not guarantee that your vehicle will not get stolen, but ensures you that the risk of theft decreases significantly.

For most insurance companies approved locks are required for closing a two-wheeler insurance. What requirements apply to your bicycle can be found in the policy conditions of the insurance company.

Requirements on approvals can differ per country, based on variables such as theft methods used and weather conditions.



The Netherlands
www.stichtingart.nl



Denmark
www.varefakta.dk



Sweden
www.sbcs.se



Finland
www.fkl.fi



United Kingdom
www.soldsecure.com



Norway
www.fgsikring.no

Key alike

The keyed-alike lock systems for E-bikes from Allegion convince with highest comfort. The Allegion lock solutions are intermateable with battery cases of leading suppliers. Hence there is only one key for the bicycle lock and the battery case of the E-bike. The lock cylinder is available for the battery cases mounted at the frame or under the rack.

This allows us to create integrated solutions in close cooperation with manufacturers, which continue to increase the range of functions, user-friendliness and active and passive safety.

Key service

It can happen that you lose your bicycle key. This is not a problem! We have a special key service website where an extra key can be ordered through and will be delivered within a few days. We produce and send keys in-house. As a result, we offer a fast service and certainty, for both consumers as dealers. You can pay with iDeal, PayPal, Creditcard or a one-time payment authorization.

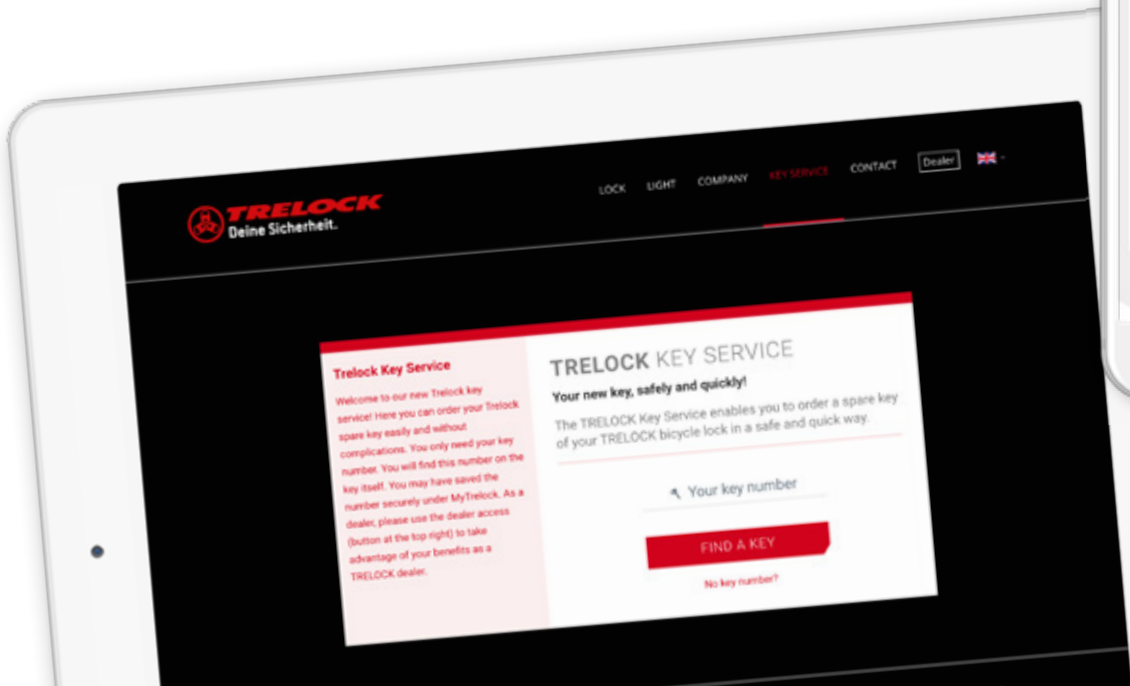
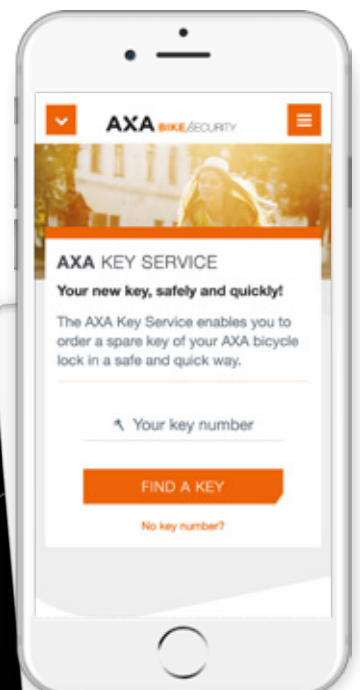

Frame locks

City and trekking bikes

UNAPPROVED

TRELOCK
RS 300
PAGE 77



AXA
Ren 2 Balloon
PAGE 78



ENTRY

AXA
Solid Plus Plug-in
PAGE 79



PREMIUM

TRELOCK
RS 453 Plug-in
PAGE 82



AXA
Defender Plug-in
PAGE 81



AXA
Block XXL Plug-in
PAGE 80



PREMIUM

AXA

Imenso Plug-in

PAGE 83



TRELOCK

RS 480/481 Plug-in

PAGE 84



ADVANCED

AXA

Victory Plug-in

PAGE 85



COMING SOON

**Next Generation
Frame lock** Plug-in

PAGE 86



Note: No rights can be derived from this information because the product is still under development

Frame locks

Measurements

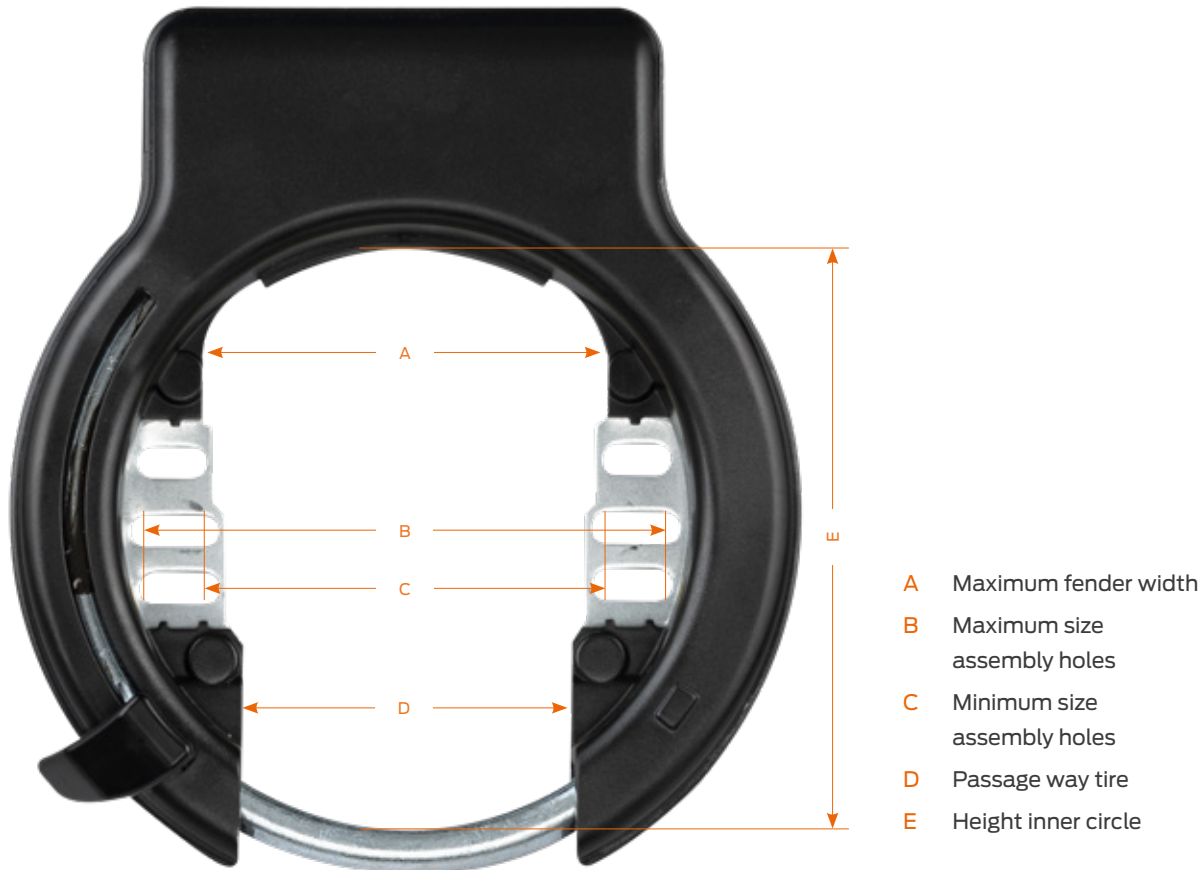

- A** Maximum fender width
- B** Maximum size assembly holes
- C** Minimum size assembly holes
- D** Passage way tire
- E** Height inner circle

Frame locks measurements

Type	A	B	C	D	E	Page
AXA Ren2	71	96,7	71	61	108	PAGE 78
AXA Solid (Plus)	71	91	71	57	102	PAGE 79
AXA Defender	63	91	71	51	102	PAGE 81
AXA Victory	72	91	71	55	102	PAGE 85
AXA Block XXL	71	98,3	83,2	56	106	PAGE 80
AXA Imenso-L	92	112,8	89,3	71	120	PAGE 101
AXA Imenso-XL	92	113,3	106,3	71	120	PAGE 101
Trelock RS 300	71	102	66	61	108	PAGE 77
Trelock RS 453	71	103	67	56	106	PAGE 98
Trelock RS 453 balloon	71	103	78	56	106	PAGE 100
Trelock RS 480	91	117	82	70	120	PAGE 101
Trelock RS 481	91	117	100	70	120	PAGE 101

Gross measurements in mm, tire clearance and screw sizes not considered

TRELOCK

RS 300



The Trelock RS 300 is a standard frame lock with wide opening. The lock offers basic security and comes with 2 keys. The Trelock RS 300 comes in a retractable and a non-retractable version and is painted in matt black.

TRELOCK RS 300

Type	RS 300 NAZ	RS 300 AZ
Art. no.	8006027	8006028
Plug-in option		
Key removable		■
Key service		
Keys	2	2
Safety catch	■	■
Caps		
Balloon	■	■
Welded all around		
Keyed alike		
Approvals		
■ Standard		

AXA

Ren 2

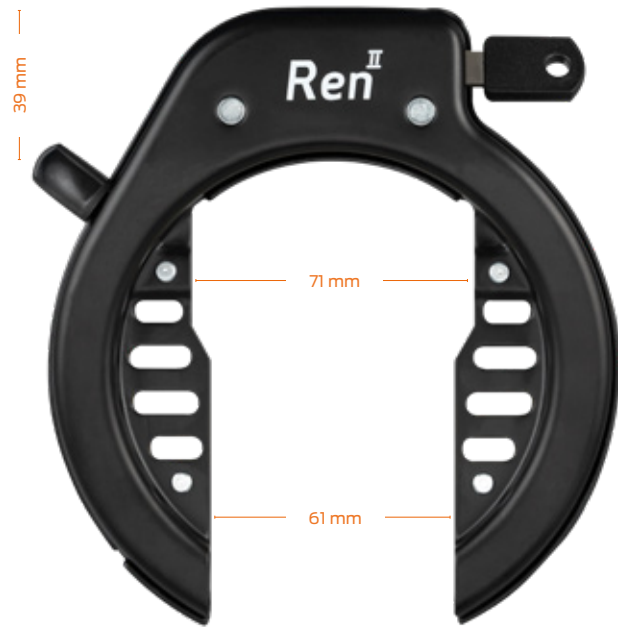

The AXA Ren is an entry level unapproved frame lock. The Ren ring lock offers basic safety and is an option for areas with very limited bike theft. The low head of the lock makes it extremely suitable for children's bicycles. The lock comes in a retractable and a non-retractable version and is painted in matt black.

AXA Ren 2

Type	Non retractable	Retractable
Art. no.	50110095	50120095
Plug-in option		
Key removable		■
Key service		
Keys	2	2
Safety catch	■	■
Caps		
Balloon		
Welded all around		
Keyed alike		
Approvals		
■ Standard		

AXA

Solid (Plus)

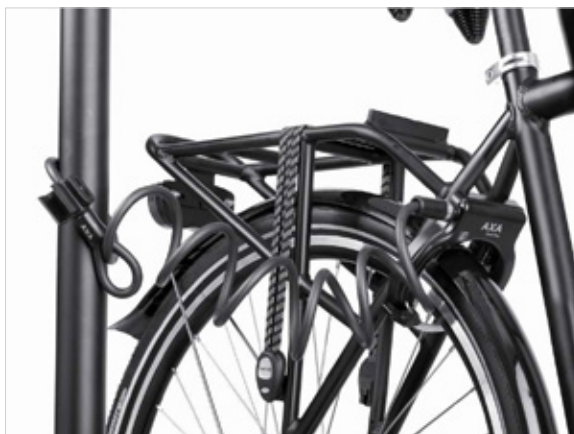

The AXA Solid (Plus) is the strong entry level lock of the AXA range. With the wide opening and the plug in option (Plus) to connect your bicycle to the fixed world by chain or cable, the bike is protected against roll-away theft.

The Solid (Plus) ring lock is equipped with an anti-drilling cylinder and hardened steel bracket. The ergonomic design of the push button and the online key service offer you additional comfort.

The Solid (Plus) is available in a non-retractable and a retractable version and can be combined with various battery pack locks for a 1 key solution.

AXA Solid (Plus)

Type	Solid	Solid Retractable	Solid Plus	Solid Plus Retractable
Art. no.	51005095 0X05	51020095 VX05	51405095 0A05	51420095 VA05
Plug-in option			■	■
Key removable		■		■
Key service	■	■	■	■
Keys	2	2	2	2
Safety catch	■	■	■	■
Caps			■	■
Balloon				
Welded all around				
Keyed alike	■	■	■	■
Approvals	ART, Sold Secure	Varefakta, SBSC, FG, FA	ART, Sold Secure	Varefakta, SBSC, FG, FA

■ Standard □ Optional

AXA Block XXL



The Block XXL security frame lock with its balloon opening allows tires up to 60 mm to be fitted. The additional plug in options of the ULC range support theft resistance against roll-away theft. The Block XXL is a solid base for your E-bike locking as it will offer a wide range of keyed alike combinations with battery locks.

AXA Block XXL

Type	Non Retractable	Retractable
Art. no.	58240056 0X05	58340056 0X05
Plug-in option	■	■
Key removable		■
Key service	■	■
Keys	2	2
Safety catch	■	■
Caps	■	■
Balloon	■	■
Welded all around		
Keyed alike	■	■
Approvals	ART	Varefakta, SBSC, FG, FA

■ Standard Custom adaptations possible

Notice

The Axa Block XXL does not match with the standard AXA plug-in chains or cables. Please use the ULC plug-in products.

AXA Defender



The AXA Defender is the most used and known ring lock in our range. The frame lock has an universal design and the option to link a plug in cable or -chain to the lock so you can lock your bike to a fixed object.

The Defender ringlock with it's limitless options for changes in colour as well as mat or glossy surface on the side covers makes the lock fit in with every bike design. The wide range of keyed alike battery locks makes this lock fit for every bike, whether with or without motor.

The Defender is available in a non-retractable and a retractable version and can be combined with various battery pack locks for a 1 key solution for E-bikes.

AXA Defender

Type	Non Retractable	Retractable
Art. no.	55555095 4405	55585195 4405
Plug-in option	■	■
Key removable		■
Key service	■	■
Keys	2	2
Safety catch	■	■
Caps	■	■
Balloon		
Welded all around		
Keyed alike	■	■
Approvals	ART, Sold Secure	Varefakta, SBSC, FG, FA

■ Standard Custom adaptations possible (ask about the many possibilities)

TRELOCK

RS 453



The Trelock RS 453 PROTECT-O-CONNECT® frame lock is made of TREDUR® steel and equipped with the high precision IN-X® cylinder technology, offering reversible keys for user convenience. For increased security demands on roll away theft, the lock can be combined with a PROTECT-O-CONNECT® chain or

cable. The RS 453 range can be used keyed alike with a wide range of E-bike battery locks. The standard version fits for tires up to 50 mm while the balloon version is very good fit for tires up to 65 mm.

TRELOCK RS 453

Type	RS 453 NAZ	RS 453 AZ	RS 453 NAZ	RS 453 AZ
Art. no.	Standard 8004768	Standard 8004766	Balloon 8004769	Balloon 8004767
Plug-in option	■	■	■	■
Key removable		■		■
Key service	■	■	■	■
Keys	2	2	2	2
Safety catch	■	■	■	■
Caps	■	■	■	■
Balloon			■	■
Welded all around				
Keyed alike	■	■	■	■
Approvals	ART	Varefakta, SBSC, FG, FA	ART	Varefakta, SBSC, FG, FA

■ Standard

AXA

Imenso



The AXA Imenso Large and X-Large Ring Locks are designed with extra large opening of 75 mm and 92 mm to fit with wide tires.

For increased security demands, the locks offers the option to use additional plug-in chains or plug-in cables.

The Locks are equipped with high-precision IN-X® cylinder technology ensuring high level of security and ease of use.

The locks can be combined with various Battery Locks as well as Folding Locks for 1-Key-Solution.

AXA Imenso

Type	Imenso Large	Imenso Large	Imenso X-Large	Imenso X-Large
Art. no.	586400560X05	587400560X05	588400560X05	589400560X05
Plug-in option	■	■	■	■
Key removable		■		■
Key service	■	■	■	■
Keys	2	2	2	2
Safety catch	■	■	■	■
Caps	■	■	■	■
Balloon			■	■
Welded all around				
Keyed alike	■	■	■	■
Approvals	ART	Varefakta, SBSC, FG, FA	ART	Varefakta, SBSC, FG, FA

■ Standard

TRELOCK

RS 480/481



The Trelock RS 480 XL and RS 481 XXL Ring Locks are designed with extra large opening of 76 mm and 92 mm to fit with wide tires.

The Locks are equipped with high-precision IN-X® cylinder technology ensuring high level of security and ease of use.

For increased security demands, the locks offers the option to use additional PROTECT-O-CONNECT® plug-in chains or plug-in cables.

The locks can be combined with various Battery Locks as well as Folding Locks for 1-Key-Solution.

TRELOCK RS 480/481

Type	RS 480 NAZ	RS 480 AZ	RS 481 NAZ	RS 481 AZ
Art. no.	8006006	8006007	8006066	8006065
Plug-in option	■	■	■	■
Key removable		■		■
Key service	■	■	■	■
Keys	2	2	2	2
Safety catch	■	■	■	■
Caps	■	■	■	■
Balloon			■	■
Welded all around				
Keyed alike	■	■	■	■
Approvals	ART	Varefakta, SBSC, FG, FA	ART	Varefakta, SBSC, FG, FA

■ Standard

AXA Victory



The AXA Victory with its seamless welded metal housing and double sided key code pattern is hard to beat. This, combined with the design options and its high end sophisticated look make this lock a perfect match for the advanced range of bikes. The AXA Victory offers keyed alike solutions for a wide range of e-bike battery locks.

AXA Victory

Type	Non retractable	Retractable
Art. no.	54000000	54020000
Plug-in option	■	■
Key removable		■
Key service	■	■
Keys	2	2
Safety catch	■	■
Caps	■	■
Balloon		
Welded all around	■	■
Keyed alike	■	■
Approvals	ART	Varefakta, SBSC, FG, FA

■ Standard Custom adaptations possible

COMING SOON

New Generation Frame Locks



The new generation frame lock has various technical improvements and the design is fully up-to-date. The frame lock is produced in the Netherlands, to maximize production flexibility and limit our carbon footprint.

The new design of the frame lock has a robust and angular look that perfectly matches modern bicycles. The welded lock housing, up to date cylinder design and square shackle pushes this lock to the top of our line in terms of security.

The new frame lock is available in 2 mounting sizes and offers an increased inner diameter of the lock. This, combined with the reduced height of the lock head which is 20% lower compared to the AXA Defender, makes for easy assembly and fit to a wide variety of frames.

To decrease the risk of roll away theft the lock offers the option to use an additional plug-in chain or cable.

Note: No rights can be derived from this information because the product is still under development

New Generation Frame Locks

Type	Non retractable	Retractable	Non retractable	Retractable
Plug-in option	■	■	■	■
Key removable		■		■
Key service	■	■	■	■
Keys	2	2	2	2
Safety catch	■	■	■	■
Caps	□	□	□	□
Balloon			■	■
Welded all around	■	■	■	■
Keyed alike	■	■	■	■
Approvals	In process		In process	

■ Standard □ Optional

Standard



Wide



TRELOCK

Folding Locks



Trelock offers wide range of Folding Locks that are the right choice to secure any Bikes and E-Bikes from entry to high-end.

The new FS 280 TWO.GO® combines basic security by hardened steel bars with super compact product size and long locking range of up to 100 cm - allowing to well secure the bike to stationary objects.

The new FS 480 COPS® and FS 580 TORO® are designed with special focus on E-Bike Security. The high attack resistance has been approved by various external parties. They are available with the new X-PRESS bracket solution - easy to use and designed to well fit on bicycle frames with low space.

The high-precision IN-X® cylinder technology ensures high level of security and ease of use. The locks can be combined with various Battery Locks and Ring Locks for 1-Key-Solution.



TRELOCK Folding Locks

Type	FS 280 TWO.GO		FS 280 Code	FS 380 X-PRESS		FS 480 COPS		FS 580 TORO
Art. no.	8005556	8005557	8006105	8006153	8006154	8005522	8005412	8005551
Length	80 cm	100 cm	100 cm	85 cm	100 cm	100 cm	130 cm	90 cm
Safety index	2 of 6		2 of 6	3 of 6		4 of 6		5 of 6
Automatic click-in	■		■	■				■
Transport bracket	X-MOVE		X-MOVE	X-PRESS (Click Bracket)		X-PRESS (Click Bracket)	X-MOVE	X-PRESS (Click Bracket)
Colour	Black		Black	Black		Black		Black
Length folded	14,5 cm	17,5 cm	17,5 cm	20 cm	22 cm	22 cm	22 cm	21,5 cm
Product weight	560 g	660 g	700 g	770 g	860 g	1200 g	1500 g	1500 g
Approvals				Sold Secure Bronze		Sold Secure Silver, Varefakta		ART 2, Sold Secure Gold, Varefakta, SBSC, FG

■ Standard

AXA

Fold Series



The AXA Fold is the newest addition to our range of folding locks. With its compact and modern design it's an excellent addition to our range.

The AXA Fold comes with a handy holder. This can be mounted to the bottle cage or you can secure it around the bar with the 2 supplied straps. The lock is positioned at the bottom of the holder, so you can easily tilt it out. Since you do not have to slide the lock out of the holder, it fits all frames. Thanks to the revolutionary locking mechanism, the lock is fixed in the holder, so that it doesn't rattle during cycling.

Thanks to its flexible joints and its light weight, the lock is extremely easy to use. The lock is made from tempered steel and is resistant to cutting and pulling.

The Fold has a convenient click-in function. There is a notch on the side where you can easily insert the lock. As soon as you do that you will hear a clear click. The key can now be removed and it is locked. The lock has a soft casing to prevent any scratches to the frame of your bike.



AXA Fold Series

Type	Fold Lite Code	Fold Lite 80/100		Fold 85/100		Fold 100 Ultra
Art. no.	59842095SC	59840895SC	59841095SC	59810895SB	59811095SB	59831095SB
Length	100 cm	85 cm	100 cm*	85 cm	100 cm*	90 cm
Safety level	7	7		9		14
Diameter link	5,5 mm	5,5 mm		7 mm		8 mm
Automatic click-in				■		■
Cylinder protected against dust dirt				■		■
Transport bracket	■	■		■		■
Colour	Black	Black		Black		Black
Length folded	18,5 cm	15 cm	18 cm	20 cm	22 cm	21,5 cm
Product weight	725 g	560 g	660 g	850 g	950 g	1500 g
Key		2 symmetrical keys		2 symmetrical keys		2 symmetrical keys
Approvals				Sold Secure Bronze (UK)		ART, Varefakta, Sold Secure Gold, FG

■ Standard * Displayed

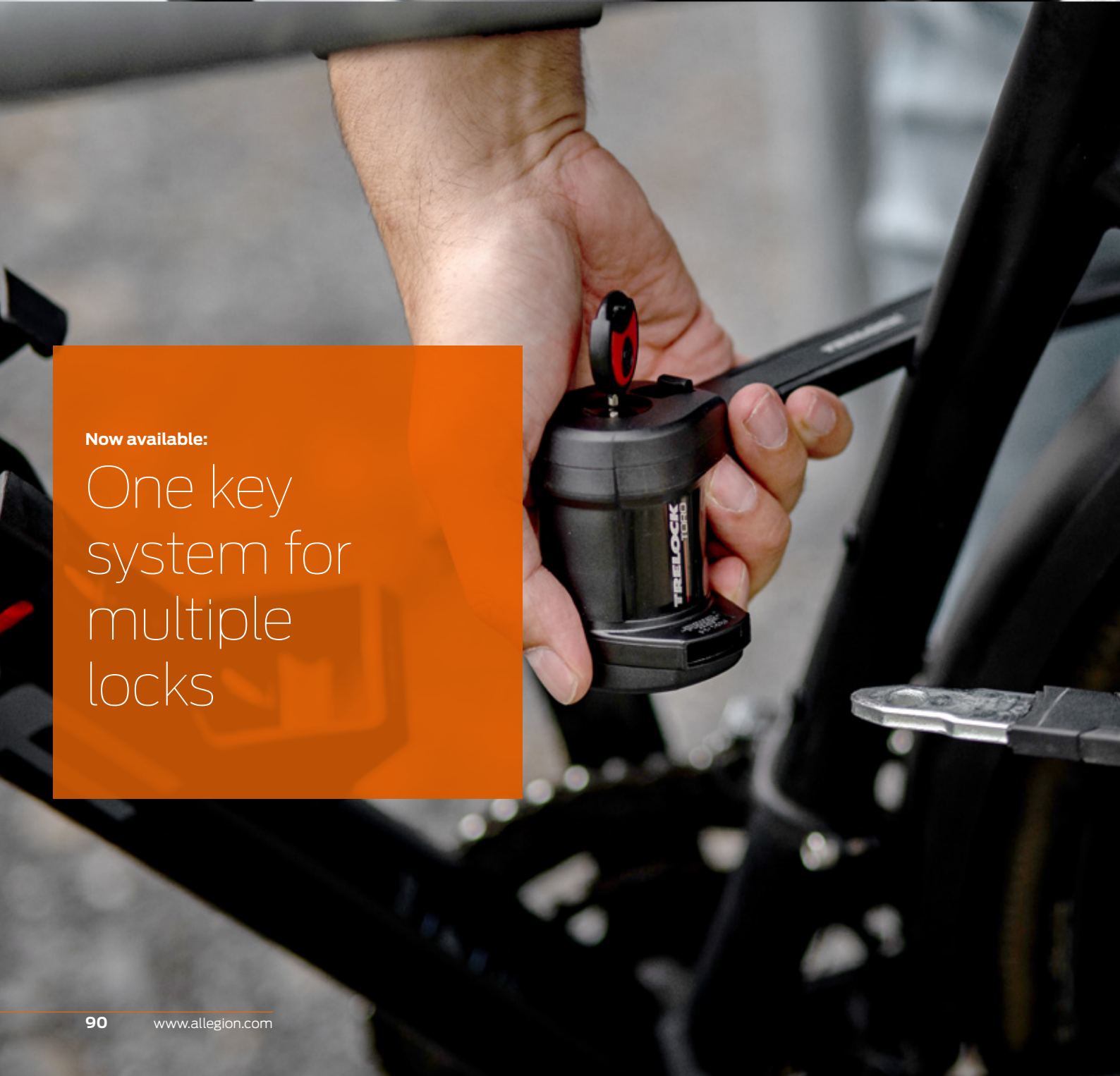

Now available:

One key
system for
multiple
locks

Keyed alike locks 1 key 2 locks

In cooperation with many E-bike component suppliers we provide the E-Bike manufacturers keyed-alike product solutions. The battery case either mounted at the frame or under the rack and the ring lock can be locked with just one key. This means the highest comfort. Customised colour variations are possible. The lock mechanisms are also available as single versions for the battery case only.



All black editions

Outside of the standard silver battery pack lock we also have the all black variants available. The completely black battery pack locks are integrated nicely into the frame, also the cylinder cover can be chosen in the colour black.

Long key

Also available with a long key.



Other possibilities

Besides the above combination, it is also possible to have the same key for a folding lock and the battery pack lock. There are multiple options for AXA and Trelock folding locks. Extra safe because the bike can be secured with 2 locks instead of 1. It can also be locked to a fixed object so the thief can not take the bike to another location.

There is also a new option. AXA has a set of the Solid Plus ring lock and the Linq City chain with the same key.



Battery lock range

The portfolio below shows you some of the most sold locks of our range of battery locks. Besides battery locks with a standard key we also have some versions with a long key which you can see in the table. Contact your sales manager to find out all the options we have available and learn more about our customized options.

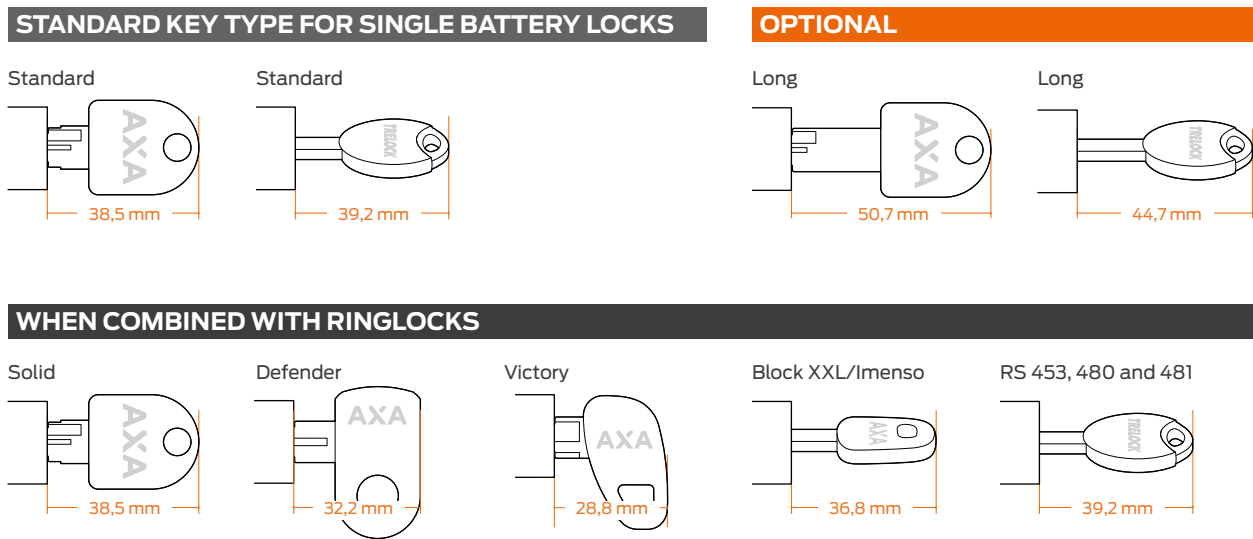

BOSCH [®] Battery locks BES3



Axial BES3

Rack BES3

Frame BES3

Bat.	Product	Art. no.		Keyed alike options available	
		AXA	Trelock	Ring locks	Folding locks
1	Axial (Powertube 500/625/750)	55922595	8005570	X	X
0	Frame (Powerpack 545/600/725/800)	55931195	8006080E	■	□
	Frame long key (Powerpack 545/600/725/800)	55931395E	8006081E	□	□
C	Rack (Powerpack 545/600/725/800)	55933195 E	8006128	■	□

■ Standard □ Optional X No

Battery Locks - Overview Battery locks

Battery types



I In tube **O** On tube **C** Carrier

BOSCH

Battery locks BES3



Powertube
500/625/750



CPT-400



Powertube 600/800

Bat.	Product	Art. no.		Keyed alike options available	
		AXA	Trelock	Ring locks	Folding locks
I	Pivot (Powertube 500/625/750)	55925595	8006000	■	□
	Pivot - long key (Powertube 500/625/750)	55925895 E	-	□	□
I	CPT-400 (Compact Powertube 400)	55932095 E	8006168	■	□
	CPT-400 long key (Compact Powertube 400)	55932195 E	8006169	□	□
I	PT600-800 (Powertube 600/800)	55936395 E	8006216	■	□
	PT600-800 long key (Powertube 600/800)	55936595 E	-	□	□

■ Standard □ Optional X No

SHIMANO

Battery locks



Rack



Frame



In tube EN805/806

Bat.	Product	Art. no.		Keyed alike options available	
		AXA	Trelock	Ring locks	Folding locks
C	Rack BT-E6000/E6001/EN404/EN405 + BM-E6000	55906095	8003940	■	□
O	Tube BT-6010/E8014/E8010/EN604/EN605/EN606 + BM E6010/E8010	55906195	8003941	■	□
I	In tube BT-E8035/E8036/EN805/EN806 + BM8031	55906495	8005339	■	□
	In tube BT-E8035/E8036/EN805/EN806 + BM8031 - long key	55906395	8005340	□	□

■ Standard □ Optional X No

Battery Locks - Overview Battery locks



Battery locks



Rack



Tube



External Cross Over EX500



ML 500-600

Bat.	Product	Art. no.		Keyed alike options available	
		AXA	Trelock	Ring locks	Folding locks
Ⓞ	Rack	55923395	X	■	X
Ⓞ	Tube	55923695	X	■	X
Ⓞ	External cross over EX500	55923895	□	■	□
	External cross over EX500 - long key	55923995	□	■	□
	ML 500-600	55911195	X	■	X

■ Standard □ Optional X No

Panasonic

Battery locks



Seat



Frame/tube



Product	Art. no.		Keyed alike options available	
	AXA	Trelock	Ring locks	Folding locks
Panasonic Seat	□	8003286	■	□
Panasonic Frame/tube	55904661	8003180	■	□

■ Standard □ Optional X No

Battery Locks - Overview Battery locks

Battery types



SLAM Universal lock Battery locks

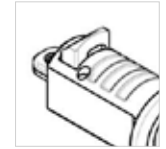
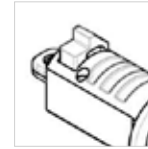
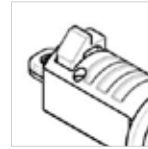
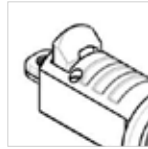

Slam

1

2

3

4

Product	Art. no.		Keyed alike options available	
	AXA	Trelock	Ring locks	Folding locks
Slam 1	55911395	□	■	X
Slam 2	55911495	□	■	X
Slam 3	55911095	□	■	X
Slam 4	55911195	□	■	X

■ Standard □ Optional X No

Battery Locks - Overview Battery locks

ELH Universal lock Battery locks



Universal lock

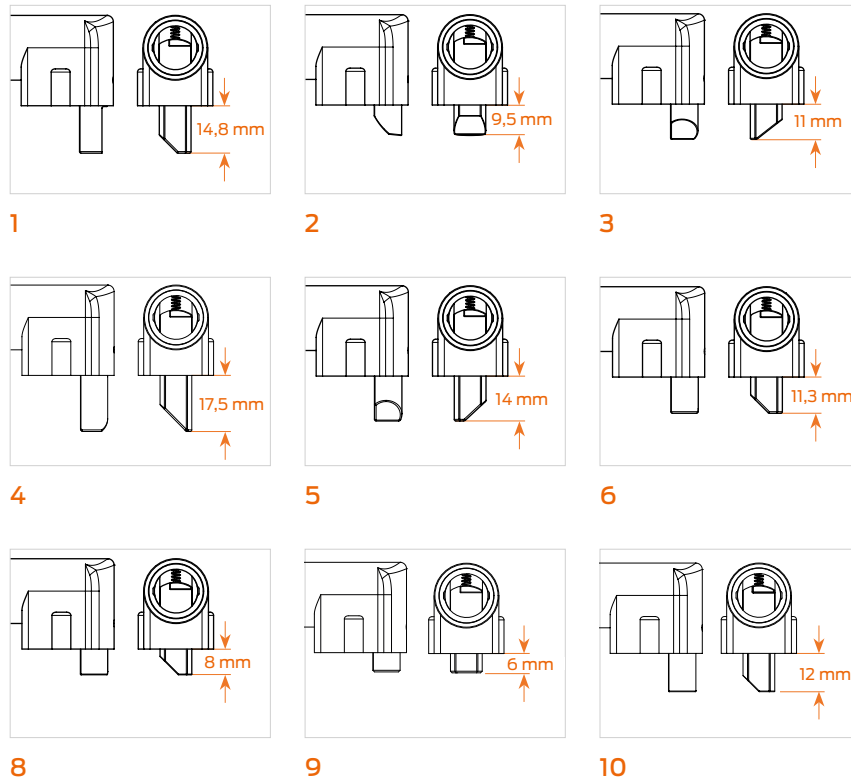

Product	Art. no.		Keyed alike options available	
	AXA	Trelock	Ring locks	Folding locks
Type 1	55927595	<input type="checkbox"/>	<input type="checkbox"/>	<input type="checkbox"/>
Type 2	55927695	<input type="checkbox"/>	<input type="checkbox"/>	<input type="checkbox"/>
Type 3		<input type="checkbox"/>	<input type="checkbox"/>	<input type="checkbox"/>
Type 4	55911895	<input type="checkbox"/>	<input type="checkbox"/>	<input type="checkbox"/>
Type 5	55911695	<input type="checkbox"/>	<input type="checkbox"/>	<input type="checkbox"/>
Type 6	55911595	<input type="checkbox"/>	<input type="checkbox"/>	<input type="checkbox"/>
Type 7	55927695E	<input type="checkbox"/>	<input type="checkbox"/>	<input type="checkbox"/>
Type 8		<input type="checkbox"/>	<input type="checkbox"/>	<input type="checkbox"/>
Type 9		<input type="checkbox"/>	<input type="checkbox"/>	<input type="checkbox"/>
Type 10		<input type="checkbox"/>	<input type="checkbox"/>	<input type="checkbox"/>

■ Standard □ Optional X No

BAFANG

Battery locks

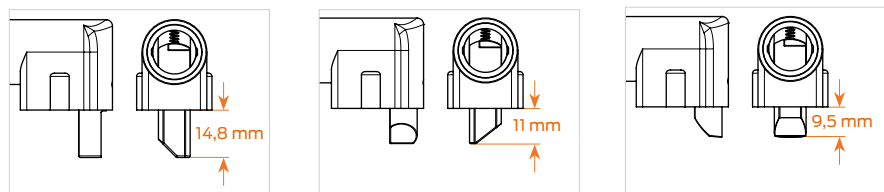

Lock

Carrier

F03

F07-F08

Product	Art. no.		Keyed alike options available	
	AXA	Trelock	Ring locks	Folding locks
Carrier	55927695E	<input type="checkbox"/>	<input checked="" type="checkbox"/>	<input type="checkbox"/>
F03	<input type="checkbox"/>	<input type="checkbox"/>	<input checked="" type="checkbox"/>	<input type="checkbox"/>
F07-F08*	55927695	<input type="checkbox"/>	<input checked="" type="checkbox"/>	<input type="checkbox"/>

■ Standard □ Optional * When ordering battery + slider, mention AXA version X No

Battery Locks - Overview Battery locks



Battery locks



DT12/SF06



GX20



BN21-BN21L-IT23-IT23L



Lock

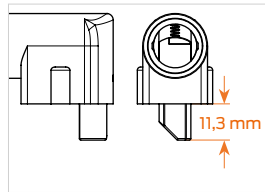

SF03

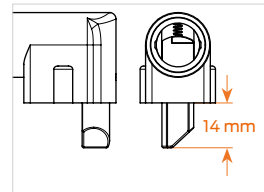

BN18

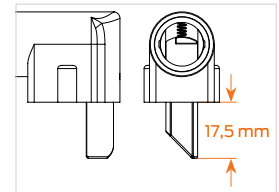

IT21

Product	Art. no.		Keyed alike options available	
	AXA	Trelock	Ring locks	Folding locks
DT12-SF06	55942095		■	X
GX20		X	■	X
BN21-BN21L-IT23-IT23L	55911795	□	■	X
SF03-SR11-SR20	55911595	□	■	□
BN18	55911695	□	■	□
IT21	55911895	□	■	□

■ Standard □ Optional X No









To get you started

In order to get you started we created an overview of our most sold ring locks and the battery locks with which you can combine it. A user friendly set because both locks can be operated with just 1 key.

STANDARD TIRE LOCKS



AXA Solid Plus



Battery lock		Bike lock	Art. no.
BOSCH  Frame BES3		AXA Solid Plus non-retractable	51965295 ABT3
		AXA Solid Plus retractable	51965195 ABT3
BOSCH  Pivot lock BES3		AXA Solid Plus non-retractable	51965295 0A05BV
		AXA Solid Plus retractable	51965195 0A05BV
BOSCH  Rack BES3		AXA Solid Plus non-retractable	51965295 AAR3E
		AXA Solid Plus retractable	51965195 AAR3E
SHIMANO Tube		AXA Solid Plus non-retractable	51965295 0A05ST
		AXA Solid Plus retractable	51965195 VA05ST
SHIMANO Rack		AXA Solid Plus non-retractable	51965295 0X05SR
		AXA Solid Plus retractable	51965195 VA05SR









TRELOCK RS453 Standard



Battery lock		Bike lock	Art. no.
BOSCH  Rack BES3		TRELOCK RS453 NAZ	8006125
		TRELOCK RS453 AZ	8006124
SHIMANO Tube		TRELOCK RS453 NAZ	8004953
		TRELOCK RS453 AZ	8004957



AXA Defender



Battery lock		Bike lock	Art. no.
BOSCH  Frame BES3 		AXA Defender non-retractable	55965295 4BT3
		AXA Defender retractable	55965195 4BT3
BOSCH  Pivot lock BES3 		AXA Defender non-retractable	55965295 4405BV
		AXA Defender retractable	55965195 4405BV
BOSCH  Rack BES3 		AXA Defender non-retractable	55965295 AR3E
		AXA Defender retractable	55965195 AR3E
SHIMANO Tube 		AXA Defender non-retractable	55965295 0001ST
		AXA Defender retractable	55965195 V001ST
SHIMANO Rack 		AXA Defender non-retractable	55965295 0001SR
		AXA Defender retractable	55965195 V001SR

AXA Victory



Battery lock		Bike lock	Art. no.
SHIMANO Tube 5000-8010 		AXA Victory non-retractable	54000003 STE
		AXA Victory retractable	54020003 ST
SHIMANO Rack 5000-8010 		AXA Victory non-retractable	54000003 SR
		AXA Victory retractable	□







□ Optional

WIDE TIRE LOCKS

TRELOCK

RS 453 Balloon









Battery lock		Bike lock	Art. no.
BOSCH  Frame BES3 		TRELOCK RS453 AZ Balloon	8006085
		TRELOCK RS453 NAZ Balloon	8006084
BOSCH  Pivot lock BES3 		TRELOCK RS453 AZ Balloon	8006075
		TRELOCK RS453 NAZ Balloon	8006076
BOSCH  Rack BES3 		TRELOCK RS453 AZ Balloon	8006127
		TRELOCK RS453 NAZ Balloon	8006126
SHIMANO Tube 5000-8010 		TRELOCK RS453 AZ Balloon	8004958
		TRELOCK RS453 NAZ Balloon	8004959

AXA

Block XXL









Battery lock		Bike lock	Art. no.
BOSCH  Frame BES3 		AXA Block XXL non retractable	58240056 BT3
		AXA Block XXL retractable	58340056 BT3
BOSCH  Pivot lock BES3 		AXA Block XXL non retractable	58240056 0X05BV
		AXA Block XXL retractable	58340056 0X05BV
BOSCH  Rack BES3 		AXA Block XXL non retractable	58240056 AR3E
		AXA Block XXL retractable	58340056 AR3E
SHIMANO Tube 		AXA Block XXL non retractable	58240056 0X05ST
		AXA Block XXL retractable	58340056 0X05ST

TRELOCK

RS 480









Battery lock		Bike lock	Art. no.
BOSCH  Frame BES3 		TRELOCK RS 480 AZ	8006087
		TRELOCK RS 480 NAZ	8006086
BOSCH  Pivot lock BES3 		TRELOCK RS 480 AZ	8006014
		TRELOCK RS 480 NAZ	8006015
SHIMANO Tube 5000-8010 		TRELOCK RS 480 AZ	8006018
		TRELOCK RS 480 NAZ	8006019
SHIMANO Rack 5000-8010 		TRELOCK RS 480 AZ	8006016
		TRELOCK RS 480 NAZ	8006017

AXA

Imenso-L



Battery lock		Bike lock	Art. no.
BOSCH  Frame BES3 		AXA Imenso-L, non retractable	58640056 BT3
		AXA Imenso-L, retractable	58740056 BT3
BOSCH  Pivot lock BES3 		AXA Imenso-L, non retractable	58640056 OX05BV
		AXA Imenso-L, retractable	58740056 OX05BV
SHIMANO Tube 5000-8010 		AXA Imenso-L, non retractable	58640056 OX05ST
		AXA Imenso-L, retractable	58740056 OX05ST
SHIMANO Rack 5000-8010 		AXA Imenso-L, non retractable	58640056 OX05SR
		AXA Imenso-L, retractable	58740056 OX05SR

Secure the ring lock to the fixed world



Many of our ring locks are equipped with the possibility to include a plug-in chain or cable. With this plug-in chain the bicycle can be connected to the fixed world. This is an additional barrier for bike thieves since they can not easily move your bicycle to a less visible area to break the lock.

For additional brand exposure we offer custom options like your own brand logo. Ask your Allegion contact person for the colour and logo possibilities.

Which plug-in chain fits on what ring lock

Ring lock	AXA DPI 8,5 mm	AXA ULC 5.5 mm	AXA ULC PRO 8,5 mm	TRELOCK ZR355 6 mm	TRELOCK ZR455 8,5 mm
AXA Solid Plus	■	■	■		
AXA Defender	■	■	■		
AXA Block XXL		■	■		
AXA Victory	■	■	■		
AXA Imenso L - XL		■	■		
TRELOCK RS430				■	■
TRELOCK RS453 (Balloon)				■	■
TRELOCK RS480 - RS481				■	■
NEXT GENERATION FRAME LOCK		■	■	■	■

Mounting made easy

For bicycles that are not equipped with standard mounting points for ring locks we offer various alternative mounting solutions, allowing you to mount the ring lock on the frame or for example on the cantilever brakes.





Wide range of Chain Guards

Allegion has a wide range of chain guards that protects the chain wheel from sand and dirt and also protects the clothing of the cyclist. We have closed and half closed chain cases, chain discs and chain guards that are perfectly suited for city and smaller bicycles. Our engineers focus on making chain guards that are easy to mount, have enough space for the chain and are quick to disassemble for service.

Custom solution

We have our own plastic factory where we can make any chain guard in any colour. It is also possible to make the chain guard and the ring in a different colour or in a matt or glossy variant. This way there are infinite possibilities to fully customize the chain guard. Our clients can distinguish their bike in the new season for a very sharp price.





AXA Fit



The AXA Fit is suited for 38 teeth chain wheels and has been tested together with a number of clients on all standard gear systems extensively and is tailor made. So this chain guard fits on a wide assortment bicycles.

The AXA Fit is clicked on the disc in a simple way. This allows them to be quickly installed at the factory and disassembled during service. To adjust the chain guard on the frame of the bike there are several mounting sets available.

The AXA Fit is wider and deeper and has therefore more space for the chain and is very silent. When the chain loosens up you will hear no noise from the chain coming against the chain guard.

Because both the chain guard and the ring are available in every colour, there are infinite possibilities to fully customize the chain guard. In addition, the cabinet is available in a matt and glossy variant.

AXA Fit

Type	Cain case	Cain case
Finnish	Glossy and matt	Glossy and matt
Colour element		Ring
Material base	ABS	ABS
Material colour element		ABS or MABS
No of chain wheels	1	1
Size chain wheel	38 t	38 t
RC size	455 – 480 mm	455 – 480 mm
Size hole crank	100 mm	100 mm

■ Standard Custom adaptations possible

Various parts

Standard version



Version with click-in ring



Both versions available in:



Matt

Glossy

Various mounting materials available



AXA

Multi open



Black



Grey

The AXA Multi is a closed chain case which is perfectly suited for city bicycles.

With a closed chain case you protect your chain from dirt and your clothing from getting stuck in the chain which can cause crashes with your bicycle.

On top of that you maintain the quality of your chain, dirt and moisture do not have any chance, which will extend the life span of your chain considerably.

The Multi can be easily mounted through a disc and click bracket. Besides that the click box rear provides a firm closure.

AXA Multi

Type	Chain case
Finnish	Glossy
Colour element	Front plate + Clickbox
Material base	ABS or PC
Material colour element	ABS
No of chain wheels	1
Size chain wheel	38 t
RC size	456-464 mm
Size hole crank	100 mm

■ Standard Custom adaptations possible

AXA

Scope 2



The AXA Scope2 is a modern shaped chain guard which is easily mounted.

This chain guard protects your clothing against damages and protects your chain against moisture and dirt.

The elegant design is complemented with a coloured strip which covers the mounting holes. The strips are made out of ABS and the screen is made from polycarbonate.



AXA Scope 2

Type	Chain guard	Chain guard	Chain guard
Finnish	Glossy	Glossy	Glossy
Colour element	Strip	Strip	Strip
Material base	ABS or PC	ABS or PC	ABS or PC
Material colour element	ABS	ABS	ABS
No of chain wheels	1	1-3	1-3
Size chain wheel	38 t	42-44 t	46-48 t
Size hole crank	115 mm	148 mm	166 mm
Distance centre crank to rear stay	325 mm	325 mm	325 mm
Connection to the rear stay	Integrated or bracket	Integrated or bracket	Integrated or bracket

■ Standard Custom adaptations possible

AXA

Mach1



AXA Mach1

Type	Chain guard
Finnish	Glossy
Colour element	-
Material base	ABS or MABS
Material colour element	-
No of chain wheels	1
Size chain wheel	36 -38 t
Size hole crank	114 mm
Distance centre crank to rear stay	-
Connection to the rear stay	Various brackets

■ Standard Custom adaptations possible



AXA Zafir



AXA Zafir

Type	Chain guard
Finnish	Glossy
Colour element	Ring
Material base	ABS or PC
Material colour element	ABS or PC
No of chain wheels	1
Size chain wheel	36 -38 t
Size hole crank	98 and 116 mm
Distance centre crank to rear stay	325 mm
Connection to the rear stay	Integrated

■ Standard Custom adaptations possible

AXA

Lite Line Tracking



AXA Lite Line Tracking

Type	Chain guard
Finnish	Glossy
Colour element	2 sizes rear leg
Material base	ABS or PC
Material colour element	ABS or PC
No of chain wheels	3
Size chain wheel	48 t
Size hole crank	216 mm
Distance centre crank	To seat stay 422-501 mm To rear stay min 315 mm
Connection to the rear stay	To seat stay or bracket

■ Standard Custom adaptations possible

Productlist index

AXA 606 15	38	New Generation Frame Locks	86
AXA 706	66	TRELOCK BIKE-i® RETRO	54
AXA Block XXL	80	TRELOCK COB LINE LS 41x (Fender)	61
AXA Blueline	61	TRELOCK COB LINE LS 42x (Integrated fender rear light)	62
AXA City rear	68	TRELOCK COB LINE LS 65x (Carrier)	62
AXA Classic	66	TRELOCK DUO FLAT	60
AXA Defender	81	TRELOCK Folding Locks	88
AXA Dwn Front lights	71	TRELOCK i-GO® VECTOR Rear light	70
AXA Dwn Rear lights	71	TRELOCK Lighthammer 60	44
AXA Echo 15	37	TRELOCK Lighthammer 80	46
AXA Ecoline 15	36	TRELOCK Lighthammer 100	47
AXA Ecoline 30	39	TRELOCK Lighthammer 130	49
AXA Fit	106	TRELOCK Lighthammer 150	50
AXA Fold Series	89	TRELOCK Lighthammer Front lights	70
AXA Imenso	83	TRELOCK Lighthammer Premium	52
AXA Juno	60	TRELOCK Lighthammer Sets	70
AXA Juno Battery	68	TRELOCK RS 300	77
AXA Lite Line Tracking	113	TRELOCK RS 453	82
AXA Mach1	110	TRELOCK RS 480/481	84
AXA Multi	108	TRELOCK TRIO FLAT	69
AXA Nox City	67	TRELOCK ZL 620	63
AXA Nox Sport	67	TRELOCK ZL 650	63
AXA Nxt 30	40		
AXA Nxt 45	42		
AXA Nxt 60	43		
AXA Nxt 80	45		
AXA Nxt 80	48		
AXA Nyx	59		
AXA Rear Reflector	63		
AXA Ren 2	78		
AXA Riff	69		
AXA Run Compact	68		
AXA Scope 2	109		
AXA Slim	59		
AXA Solid (Plus)	79		
AXA Victory	85		
AXA Visto 3 Set	64		
AXA Zafir	112		

About Allegion™

Allegion (NYSE: ALLE) is a global pioneer in the field of safety and security. We keep people and their property safe, wherever they are, bringing together simple solutions and advanced technology.

For more, visit allegion.com



Allegion OEM

Energiestraat 2
3903 AV Veenendaal
The Netherlands

Tel: +31 318 536 220
Email: info.axa.bike@allegion.com
Web: axabikesecurity.com and trelock.de